

KEMPARTS®

PROFESSIONAL
AUTOMOTIVE PARTS



LÍNEAS — DE — BULBOS

2024



KLB-001

**EXHAUSTIVOS PROCESOS DE CALIDAD QUE
GARANTIZAN LA SEGURIDAD DE TU FAMILIA**

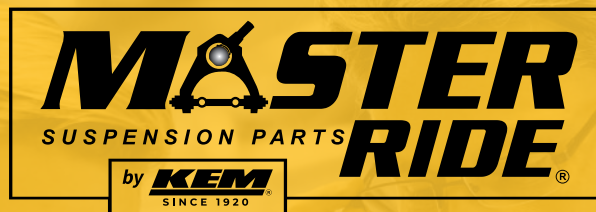

**DESCUBRE LA LÍNEA DE SUSPENSIÓN
MÁS DURADERA EN EL MERCADO**



ÍNDICE

LÍNEAS DE BULBOS 2024

BULBO DE FRENO	PÁG.
AUDI	1
BMW	
CADILLAC	
CHEVROLET	
CHRYSLER	2
DODGE	3
FORD	4
GMC	
HONDA	
HUMMER	
INFINITI	5
JEEP	
LINCOLN	6
MERCURY	
MINI	
MITSUBISHI	
NISSAN	8
PONTIAC	
PORSCHE	
RAM	
RENAULT	9
SEAT	
SUZUKI	
TOYOTA	10
VOLKSWAGEN	

BULBO DE MOTOVENTILADOR	PÁG.
AUDI	17
BUICK	
CHEVROLET	
CHRYSLER	
DODGE	18
FORD	
HONDA	19
LINCOLN	
MERCURY	
NISSAN	
SEAT	20
VOLKSWAGEN	

BULBO DE PRESIÓN DE ACEITE	PÁG.
AUDI	29
BUICK	
CADILLAC	30
CHEVROLET	
CHRYSLER	35
DODGE	37
FORD	40
GMC	44
HONDA	45
HUMMER	
HYUNDAI	46

BULBO DE PRESIÓN DE ACEITE	PÁG.
JEEP	46
KIA	47
LINCOLN	
MAZDA	48
MERCURY	
MINI	49
MITSUBISHI	
NISSAN	
OLDSMOBILE	51
PEUGEOT	
PONTIAC	
PORSCHE	
RAM	52
RENAULT	
SEAT	53
SUBARU	
SUZUKI	
TOYOTA	
VAM	54
VOLKSWAGEN	

BULBO DE PRESIÓN DE ACEITE DE DIRECCIÓN	PÁG.
NISSAN	67

BULBO DE PRESIÓN DE ACEITE DE TRANSMISIÓN AUTOMÁTICA	PÁG.
HONDA	68
MAZDA	

BULBO DE PRESIÓN DE ACEITE PARA VÁLVULA VVT	PÁG.
HONDA	70

BULBO DE REVERSA	PÁG.
CADILLAC	71
CHEVROLET	
FORD	
KIA	
NISSAN	
PONTIAC	72
RENAULT	
SEAT	
SUZUKI	73
TOYOTA	
VOLKSWAGEN	

BULBO DEPÓSITO ANTICONGELANTE	PÁG.
VOLKSWAGEN	77

BULBO DE FRENO**AUDI**

MODELO	AÑO	LTS.	CIL.	MODO DE INYECCIÓN	CARACTERÍSTICAS	NO. DE PARTE	
S3 TURBO	2004	1.8	4	MPFI	SWITCH DE STOP	EGK-730	15
TT QUATTRO TURBO	00-06	1.8	4	MPFI	4 TERMINALES	EGK-722	14
TT TURBO	00-06	1.8	4	MPFI	4 TERMINALES	EGK-722	14

BMW

MODELO	AÑO	LTS.	CIL.	MODO DE INYECCIÓN	CARACTERÍSTICAS	NO. DE PARTE	
135i	08-10	3.0	6	MPFI	2 TERMINALES	EGK-704	13
X3	04-05	2.5	6	MPFI	2 TERMINALES	EGK-704	13
	04-06	3.0					
X5	03-06	3.0	6	MPFI	2 TERMINALES	EGK-704	13
	04-06	4.4	8				

CADILLAC

MODELO	AÑO	LTS.	CIL.	MODO DE INYECCIÓN	CARACTERÍSTICAS	NO. DE PARTE	
ESCALADE	02-05	5.3	8	MPFI	6 TERMINALES	EGK-713	13
	02-06	6.0					
ESCALADE ESV	03-06	6.0	8	MPFI	6 TERMINALES	EGK-713	13
ESCALADE EXT	03-06	6.0	8	MPFI	6 TERMINALES	EGK-713	13

CHEVROLET

MODELO	AÑO	LTS.	CIL.	MODO DE INYECCIÓN	CARACTERÍSTICAS	NO. DE PARTE	
AVEO	08-18	1.6	4	MPFI	4 TERMINALES	EGK-718	14
C1500	00-01	4.3	6	MPFI	6 TERMINALES	EGK-713	13
EXPRESS 1500	03-06	4.3	6	MPFI	6 TERMINALES	EGK-713	13
	03-07	5.3	8		4 TERMINALES		
	08-11						
EXPRESS 2500	08-11	6.0	8	MPFI	4 TERMINALES	EGK-707	13
EXPRESS 3500	03-07	6.0	8	MPFI	6 TERMINALES	EGK-713	13
	08-11				4 TERMINALES	EGK-707	
OPTRA	06-10	2.0	4	MPFI	4 TERMINALES	EGK-718	15
SILVERADO 1500	99-06	4.3	6	MPFI	6 TERMINALES	EGK-713	13
	07-10				4 TERMINALES	EGK-707	
SILVERADO 2500	99-04	5.3	8	MPFI	6 TERMINALES	EGK-713	13
	01-02	5.7					

BULBO DE FRENO

CHEVROLET

MODELO	AÑO	LTS.	CIL.	MODO DE INYECCIÓN	CARACTERÍSTICAS	NO. DE PARTE	
SILVERADO 3500	01-06	6.0	8	MPFI	6 TERMINALES	EGK-713	13
	04-06	5.7			4 TERMINALES	EGK-707	
	2007						
SPARK CLASSIC	11-12	1.2	4	MPFI	4 TERMINALES	EGK-718	14
SUBURBAN	01-06	5.3	8	MPFI	6 TERMINALES	EGK-713	13
SUBURBAN 2500	01-06	6.0	8	MPFI	6 TERMINALES	EGK-713	13
TRAIL BLAZER	2006	5.3	8	MPFI	6 TERMINALES	EGK-713	13
	02-07	4.2	6				
TRAIL BLAZER EXT	02-06	4.2	6	MPFI	6 TERMINALES	EGK-713	13
	03-06	5.3	8				
TRAVERSE	2009	3.6	6	MPFI	6 TERMINALES	EGK-713	13

CHRYSLER

MODELO	AÑO	LTS.	CIL.	MODO DE INYECCIÓN	CARACTERÍSTICAS	NO. DE PARTE	
200	12-13	3.6	6	MPFI	6 TERMINALES	EGK-714	13
	12-14	2.4	4				
300C	05-10	5.7	8	MPFI	6 TERMINALES	EGK-706	13
	06-10	3.5	6				
300C SRT-8	06-08	6.1	8	MPFI	6 TERMINALES	EGK-706	13
300M	99-04	3.5	6	MPFI	6 TERMINALES	EGK-706	13
CIRRUS	96-00	2.5	6	MPFI	6 TERMINALES	EGK-706	13
CIRRUS TURBO	97-00	2.4	4	MPFI	6 TERMINALES	EGK-706	13
CONCORDE	94-97	3.5	6	MPFI	6 TERMINALES	EGK-706	13
	2002						
GRAND VOYAGER	94-00	3.8	6	MPFI	6 TERMINALES	EGK-706	13
LEBARON	94-95	2.5	4	MPFI	6 TERMINALES	EGK-706	13
NEW YORKER	94-95	3.5	6	MPFI	6 TERMINALES	EGK-706	13
TOWN & COUNTRY	94-00	3.8	6	MPFI	6 TERMINALES	EGK-706	13
	11-16	3.6					
VOYAGER	94-00	3.3	6	MPFI	6 TERMINALES	EGK-706	13
	97-99	3.8					

BULBO DE FRENO**DODGE**

MODELO	AÑO	LTS.	CIL.	MODO DE INYECCIÓN	CARACTERÍSTICAS	NO. DE PARTE	
ATTITUDE	06-11	1.4	4	MPFI	4 TERMINALES	EGK-721	14
		1.6				EGK-715	13
	15-23	1.2	3				
ATOS	01-04	1.0	4	MPFI	SWITCH DE STOP	EGK-729	15
	05-12	1.1					
AVENGER	09-10	2.0	4	MPFI	6 TERMINALES	EGK-714	13
		3.5	6				
		09-14	2.4				
CALIBER	09-12	2.4	4	MPFI	6 TERMINALES	EGK-714	13
CHALLENGER R/T	09-14	5.7	8	MPFI	6 TERMINALES	EGK-706	13
CHALLENGER SRT-8	08-10	6.1	8	MPFI	6 TERMINALES	EGK-706	13
	11-14	6.4					
CHALLENGER SXT	13-14	3.6	6	MPFI	6 TERMINALES	EGK-706	13
CHARGER	06-10	3.5	6	MPFI	6 TERMINALES	EGK-706	13
CHARGER R/T	06-10	5.7	8	MPFI	6 TERMINALES	EGK-706	13
CHARGER SRT-8	07-10	6.1	8	MPFI	6 TERMINALES	EGK-706	13
DURANGO	1998	5.2	8	MPFI	6 TERMINALES	EGK-706	13
GRAND CARAVAN	2017	3.6	6	MPFI	6 TERMINALES	EGK-706	13
INTREPID	94-96	3.3	6	MPFI	6 TERMINALES	EGK-706	13
	94-97	3.5					
	98-00	3.2					
	1998	2.7					
	00-01	3.5					
JOURNEY	09-10	2.4	4	MPFI	6 TERMINALES	EGK-714	13
		3.5	6				
NEON	95-00	2.0	4	MPFI	6 TERMINALES	EGK-706	13
RAM 1500	94-98	3.9	6	MPFI	6 TERMINALES	EGK-706	13
RAM 2500	1998	5.2	8	MPFI	6 TERMINALES	EGK-706	13
		5.9					
RAM VAN 1500	1999	3.9	6	MPFI	6 TERMINALES	EGK-706	13
RAM VAN 2500	1999	5.2	8	MPFI	6 TERMINALES	EGK-706	13
RAM VAN 3500	1999	5.9	8	MPFI	6 TERMINALES	EGK-706	13
SHADOW TURBO	1994	2.5	4	MPFI	6 TERMINALES	EGK-706	13
SPIRIT TURBO	94-95	2.5	4	MPFI	6 TERMINALES	EGK-706	13
STRATUS	95-06	2.0	4	MPFI	6 TERMINALES	EGK-706	13
		2.4					

BULBO DE FRENO

FORD

MODELO	AÑO	LTS.	CIL.	MODO DE INYECCIÓN	CARACTERÍSTICAS	NO. DE PARTE	
ESCAPE	01-06	3.0	6	MPFI	2 TERMINALES	EGK-711	13
EXPEDITION	02-04	4.6	8	MPFI	4 TERMINALES	EGK-712	13
	02-06	5.4					
F-150	04-08	4.2	6	MPFI	4 TERMINALES	EGK-712	13

GMC

MODELO	AÑO	LTS.	CIL.	MODO DE INYECCIÓN	CARACTERÍSTICAS	NO. DE PARTE	
SIERRA 1500	07-10	5.3	8	MPFI	4 TERMINALES	EGK-707	13
SIERRA 1500 DENALI	07-10	6.2	8	MPFI	4 TERMINALES	EGK-707	13

HONDA

MODELO	AÑO	LTS.	CIL.	MODO DE INYECCIÓN	CARACTERÍSTICAS	NO. DE PARTE	
ACCORD	03-07	3.0	6	MPFI	4 TERMINALES	EGK-709	13
	08-12	3.5					
ACCORD EX / LX	03-12	2.4	4	MPFI	4 TERMINALES	EGK-709	13
ACCORD LX	2007	2.4	4	MPFI	4 TERMINALES	EGK-710	13
CIVIC	03-05	1.7	4	MPFI	4 TERMINALES	EGK-709	13
	07-09	2.0					
	07-13	1.8					
	12-13	2.4					
CR-V	02-06	2.4	4	MPFI	4 TERMINALES	EGK-709	13
	08-13						
CROSSTOUR	12-13	3.5	6	MPFI	4 TERMINALES	EGK-709	13
FIT	11-13	1.5	4	MPFI	4 TERMINALES	EGK-709	13
ODYSSEY	03-13	3.5	6	MPFI	4 TERMINALES	EGK-709	13
PILOT	05-13	3.5	6	MPFI	4 TERMINALES	EGK-709	13
RIDGELINE	07-13	3.5	6	MPFI	4 TERMINALES	EGK-709	13

HUMMER

MODELO	AÑO	LTS.	CIL.	MODO DE INYECCIÓN	CARACTERÍSTICAS	NO. DE PARTE	
H2	05-07	6.0	8	MPFI	6 TERMINALES	EGK-713	13
	08-09	6.2			4 TERMINALES	EGK-707	

BULBO DE FRENO**INFINITI**

MODELO	AÑO	LTS.	CIL.	MODO DE INYECCIÓN	CARACTERÍSTICAS	NO. DE PARTE	
FX35	2012	3.5	6	MPFI	4 TERMINALES	EGK-719	14
FX37	2013	3.7	6	MPFI	4 TERMINALES	EGK-719	14
FX50	12-13	5.0	8	MPFI	4 TERMINALES	EGK-719	14
G37	12-13	3.7	6	MPFI	4 TERMINALES	EGK-719	14
M37	12-13	3.7	6	MPFI	4 TERMINALES	EGK-719	14
M56	12-13	5.6	8	MPFI	4 TERMINALES	EGK-719	14
Q45	04-06	4.5	8	MPFI	4 TERMINALES	EGK-708	14
Q60	14-15	3.7	6	MPFI	4 TERMINALES	EGK-719	14
Q70	2014	3.7	6	MPFI	4 TERMINALES	EGK-719	14
		5.6	8				
QX56	12-13	5.6	8	MPFI	4 TERMINALES	EGK-719	14
QX80	17-22	5.6	8	MPFI	4 TERMINALES	EGK-719	14
I30	98-99	3.0	6	MPFI	2 TERMINALES	EGK-723	14

JEEP

MODELO	AÑO	LTS.	CIL.	MODO DE INYECCIÓN	CARACTERÍSTICAS	NO. DE PARTE	
CHEROKEE	98-01	4.0	6	MPFI	6 TERMINALES	EGK-706	13
COMMANDER	06-07	4.7	8	MPFI	6 TERMINALES	EGK-714	13
	06-10	5.7					
COMPASS	09-17	2.4	4	MPFI	6 TERMINALES	EGK-714	13
GRAND CHEROKEE	94-04	4.0	6	MPFI	6 TERMINALES	EGK-706	13
	94-98	5.2					
	1998	5.9					
	00-04	4.7	8			EGK-714	
	05-09	4.7					
	05-10	5.7					
07-10	3.7	6					
GRAND CHEROKEE SRT-8	06-10	6.1	8	MPFI	6 TERMINALES	EGK-714	13
PATRIOT	09-16	2.4	4	MPFI	6 TERMINALES	EGK-714	13
WRANGLER	97-02	2.5	4	MPFI	6 TERMINALES	EGK-706	13
		2.4					
	03-06	4.0	6				
		07-11					
	12-17	3.6					

BULBO DE FRENO

LINCOLN

MODELO	AÑO	LTS.	CIL.	MODO DE INYECCIÓN	CARACTERÍSTICAS	NO. DE PARTE	
MARK LT	06-08	5.4	8	MPFI	4 TERMINALES	EGK-712	13
NAVIGATOR	02-07	5.4	8	MPFI	4 TERMINALES	EGK-712	13

MERCURY

MODELO	AÑO	LTS.	CIL.	MODO DE INYECCIÓN	CARACTERÍSTICAS	NO. DE PARTE	
MARINER	05-07	3.0	6	MPFI	2 TERMINALES	EGK-711	13

MINI

MODELO	AÑO	LTS.	CIL.	MODO DE INYECCIÓN	CARACTERÍSTICAS	NO. DE PARTE	
COOPER	06-10	1.6	4	MPFI	2 TERMINALES	EGK-704	13

MITSUBISHI

MODELO	AÑO	LTS.	CIL.	MODO DE INYECCIÓN	CARACTERÍSTICAS	NO. DE PARTE	
LANCER	13-15	2.0	4	MPFI	4 TERMINALES	EGK-715	13
LANCER GTS	13-15	2.4	4	MPFI	4 TERMINALES	EGK-715	13
LANCER TURBO	2014	2.0	4	MPFI	4 TERMINALES	EGK-715	13
MIRAGE	15-19	1.2	3	MPFI	4 TERMINALES	EGK-715	13
MIRAGE G4	2019 21-23	1.2	3	MPFI	4 TERMINALES	EGK-715	13
OUTLANDER	07-09	3.0	6	MPFI	4 TERMINALES	EGK-715	13

NISSAN

MODELO	AÑO	LTS.	CIL.	MODO DE INYECCIÓN	CARACTERÍSTICAS	NO. DE PARTE	
350Z	03-06	3.5	6	MPFI	SWITCH DE STOP	EGK-727	14
370Z	09-20	3.7	6	MPFI	4 TERMINALES	EGK-719	14
ALTIMA	96-01	2.4	4	MPFI	2 TERMINALES	EGK-723	14
	2002	2.5					
		07-10	2.5		4	4 TERMINALES	EGK-708
	03-12		3.5		6	SWITCH DE STOP	EGK-727
		11-12	2.5		4	4 TERMINALES	EGK-719
	3.5		6				

BULBO DE FRENO**NISSAN**

MODELO	AÑO	LTS.	CIL.	MODO DE INYECCIÓN	CARACTERÍSTICAS	NO. DE PARTE	
APRIO	08-10	1.6	4	MPFI	4 TERMINALES	EGK-724	14
					SWITCH DE STOP	EGK-728	15
ARMADA	05-15	5.6	8	MPFI	SWITCH DE STOP	EGK-727	14
FRONTIER	01-04	2.4	4	MPFI	2 TERMINALES	EGK-723	14
		3.3	6		4 TERMINALES	EGK-708	13
	06-08	2.4	4		SWITCH DE STOP	EGK-727	14
		08-15	4.0		6	4 TERMINALES	EGK-708
	08-19		4.0		6	SWITCH DE STOP	EGK-727
	11-15	2.4				4	4 TERMINALES
GT-R TURBO	17-18	3.8	6	MPFI	4 TERMINALES	EGK-719	14
LUCINO	97-00	1.6	4	MPFI	2 TERMINALES	EGK-723	14
		2.0					
MAXIMA	92-93	3.0	6	MPFI	2 TERMINALES	EGK-723	14
	95-99				SWITCH DE STOP	EGK-727	
	99-01				3.5	4 TERMINALES	EGK-708
	02-08	EGK-719				14	
	09-11						
12-14							
MURANO	04-05	3.5	6	MPFI	SWITCH DE STOP	EGK-727	14
	06-07				4 TERMINALES	EGK-708	13
	2008				SWITCH DE STOP	EGK-727	14
	09-14				4 TERMINALES	EGK-719	14
NP300	10-15	2.4	4	MPFI	2 TERMINALES	EGK-723	14
NP300 TD	09-15	2.5	4	MPFI	2 TERMINALES	EGK-723	14
NV2500	2013	4.0	6	MPFI	4 TERMINALES	EGK-708	13
		5.6	8				
PATHFINDER	97-00	3.3	6	MPFI	2 TERMINALES	EGK-723	14
	01-02	3.5			4 TERMINALES	EGK-708	13
	03-04						
	05-12				4.0		
PLATINA	02-10	1.6	4	MPFI	4 TERMINALES	EGK-717	14
					SWITCH DE STOP	EGK-728	
QUEST	97-98	3.0	6	MPFI	2 TERMINALES	EGK-723	14
	99-02	3.3			4 TERMINALES	EGK-708	13
	04-08	3.5					
ROGUE	08-13	2.5	4	MPFI	4 TERMINALES	EGK-708	13
SENTRA	1992	1.6	4	MPFI	2 TERMINALES	EGK-723	14
	96-00						
	01-01	2.0			SWITCH DE STOP	EGK-727	
	01-06						

BULBO DE FRENO

NISSAN

MODELO	AÑO	LTS.	CIL.	MODO DE INYECCIÓN	CARACTERÍSTICAS	NO. DE PARTE	
SENTRA	03-06	1.8	4	MPFI	4 TERMINALES	EGK-708	13
	02-09	2.5			SWITCH DE STOP	EGK-727	14
	07-12	2.0			4 TERMINALES	EGK-708	13
	17-19	1.8				EGK-720	14
SENTRA NISMO	18-19	1.6	4	MPFI	4 TERMINALES	EGK-720	14
SENTRA SE-R	03-12	2.5	4	MPFI	4 TERMINALES	EGK-708	13
TIIDA	07-18	1.8	4	MPFI	4 TERMINALES	EGK-708	13
	10-11				SWITCH DE STOP	EGK-727	14
TITAN	06-15	5.6	8	MPFI	4 TERMINALES	EGK-708	13
	11-15				SWITCH DE STOP	EGK-727	14
TSUBAME	2000	1.6	4	MPFI	2 TERMINALES	EGK-723	14
TSURU	1985	1.5	4	CARBURADO	2 TERMINALES	EGK-723	14
	86-92	1.6					
	92-17			MPFI			
	93-96	2.0					
	93-97	1.6					
URVAN	00-08	2.4	4	MPFI	2 TERMINALES	EGK-723	14
	10-11	2.5					
URVAN TD	09-11	3.0	4	MPFI	2 TERMINALES	EGK-723	14
VERSA	2012	1.6	4	MPFI	4 TERMINALES	EGK-708	13
X-TRAIL	02-03	2.5	4	MPFI	SWITCH DE STOP	EGK-727	14
	04-08				4 TERMINALES	EGK-708	13
	11-12						
XTERRA	00-04	2.4	4	MPFI	2 TERMINALES	EGK-723	14
		3.3	6				
	06-07	4.0			4 TERMINALES	EGK-708	13

PONTIAC

MODELO	AÑO	LTS.	CIL.	MODO DE INYECCIÓN	CARACTERÍSTICAS	NO. DE PARTE	
G3	2009	1.6	4	MPFI	4 TERMINALES	EGK-718	14

PORSCHE

MODELO	AÑO	LTS.	CIL.	MODO DE INYECCIÓN	CARACTERÍSTICAS	NO. DE PARTE	
CAYENNE	03-06	4.5	8	MPFI	4 TERMINALES	EGK-722	14
CAYENNE TURBO	03-06	4.5	8	MPFI	4 TERMINALES	EGK-722	14

BULBO DE FRENO**RAM**

MODELO	AÑO	LTS.	CIL.	MODO DE INYECCIÓN	CARACTERÍSTICAS	NO. DE PARTE	
DAKOTA	2011	3.7	6	MPFI	6 TERMINALES	EGK-706	13

RENAULT

MODELO	AÑO	LTS.	CIL.	MODO DE INYECCIÓN	CARACTERÍSTICAS	NO. DE PARTE	
CLIO	02-06	2.0	4	MPFI	4 TERMINALES	EGK-717	14
					SWITCH DE STOP	EGK-728	15
	02-10	1.6			4 TERMINALES	EGK-717	14
					SWITCH DE STOP	EGK-728	15
KANGOO	07-07	1.6	4	MPFI	SWITCH DE STOP	EGK-728	15
KANGOO EXPRESS	08-11	1.6	4	MPFI	4 TERMINALES	EGK-725	14
KANGOO EXPRESS / TD	09-10	1.5	4	MPFI	4 TERMINALES	EGK-725	14
MEGANE	2001	2.0	4	MPFI	4 TERMINALES	EGK-717	14
SANDERO	10-14	1.6	4	MPFI	4 TERMINALES	EGK-724	14
					SWITCH DE STOP	EGK-728	15
SCENIC	01-04	2.0	4	MPFI	4 TERMINALES	EGK-717	14
TRAFIC	2012	2.0	4	MPFI	4 TERMINALES	EGK-717	14
	12-13				SWITCH DE STOP	EGK-728	15
TRAFIC TD	08-12	1.9	4	MPFI	4 TERMINALES	EGK-717	14
	08-13				SWITCH DE STOP	EGK-728	15

SEAT

MODELO	AÑO	LTS.	CIL.	MODO DE INYECCIÓN	CARACTERÍSTICAS	NO. DE PARTE	
CORDOBA	01-02	1.6	4	MPFI	4 TERMINALES	EGK-722	14

SUZUKI

MODELO	AÑO	LTS.	CIL.	MODO DE INYECCIÓN	CARACTERÍSTICAS	NO. DE PARTE	
AERIO	06-07	2.3	4	MPFI	SWITCH DE STOP	EGK-726	14
GRAND VITARA	06-08	2.7	6	MPFI	SWITCH DE STOP	EGK-726	14
	09-10	3.2					
	09-13	2.4					
KIZASHI	10-13	2.4	4	MPFI	SWITCH DE STOP	EGK-726	14
SX4	08-13	2.0	4	MPFI	SWITCH DE STOP	EGK-726	14

BULBO DE FRENO

TOYOTA

MODELO	AÑO	LTS.	CIL.	MODO DE INYECCIÓN	CARACTERÍSTICAS	NO. DE PARTE	
4RUNNER	03-05	4.7	8	MPFI	SWITCH DE STOP	EGK-726	14
CAMRY	10-11	3.5	6	MPFI	4 TERMINALES	EGK-716	14
	12-17	2.5	4		SWITCH DE STOP	EGK-726	
COROLLA	05-08	1.8	4	MPFI	4 TERMINALES	EGK-705	13
	09-12	2.4			SWITCH DE STOP	EGK-726	14
	09-19	1.8					
FJ CRUISER	08-14	4.0	6	MPFI	SWITCH DE STOP	EGK-726	14
HIACE	07-11	2.7	4	MPFI	SWITCH DE STOP	EGK-726	14
	15-16						
HIGHLANDER	08-09	3.5	6	MPFI	4 TERMINALES	EGK-705	13
	14-15				SWITCH DE STOP	EGK-726	14
LAND CRUISER	2011	5.7	8	MPFI	4 TERMINALES	EGK-716	14
	13-21						
MATRIX	2010	1.8	4	MPFI	SWITCH DE STOP	EGK-726	14
	10-13	2.4					
PRIUS HÍBRIDO	10-11	1.8	4	MPFI	4 TERMINALES	EGK-716	14
RAV4	09-12	2.5	4	MPFI	4 TERMINALES	EGK-716	14
		3.5	6				
SEQUOIA	08-09	4.7	8	MPFI	SWITCH DE STOP	EGK-726	14
	10-12	4.6					
	10-17	5.7					
SIENNA	2017	3.5	6	MPFI	4 TERMINALES	EGK-716	14
	11-15				SWITCH DE STOP	EGK-726	
	14-20						
TACOMA	06-09	4.0	6	MPFI	SWITCH DE STOP	EGK-726	14
TUNDRA	07-07	4.0	6	MPFI	SWITCH DE STOP	EGK-726	14
	07-09	4.7	8				
	09-17	5.7					
YARIS	09-18	1.5	4	MPFI	SWITCH DE STOP	EGK-726	14

VOLKSWAGEN

MODELO	AÑO	LTS.	CIL.	MODO DE INYECCIÓN	CARACTERÍSTICAS	NO. DE PARTE	
BEETLE	98-02	2.0	4	MPFI	SWITCH DE STOP	EGK-730	15
	00-02	1.8					
	01-05	2.0					
	06-10	2.5	5		4 TERMINALES	EGK-722	14
	98-10	2.0	4				
BORA	06-09	2.5	5	MPFI	4 TERMINALES	EGK-722	14

BULBO DE FRENO

VOLKSWAGEN

MODELO	AÑO	LTS.	CIL.	MODO DE INYECCIÓN	CARACTERÍSTICAS	NO. DE PARTE	
BORA GLI	2006	2.0	4	MPFI	4 TERMINALES	EGK-722	14
BORA TDI	08-09	1.9	4	MPFI	4 TERMINALES	EGK-722	14
CABRIO	96-02	2.0	4	MPFI	SWITCH DE STOP	EGK-730	15
EUROVAN	01-02	2.5	5	MPFI	SWITCH DE STOP	EGK-730	15
	2001				4 TERMINALES	EGK-722	14
EUROVAN VR6	00-02	2.8	6	MPFI	4 TERMINALES	EGK-722	14
					SWITCH DE STOP	EGK-730	15
GOLF A2	87-92	1.8	4	MPFI	SWITCH DE STOP	EGK-730	15
	87-99						
	90-92	2.0					
GOLF A3	93-99	1.8	4	MPFI	SWITCH DE STOP	EGK-730	15
		2.0					
	1999	1.8			4 TERMINALES	EGK-722	14
		2.0					
GOLF A3 VR6	96-99	2.8	6	MPFI	SWITCH DE STOP	EGK-730	16
GOLF A4	00-06	2.0	4	MPFI	4 TERMINALES	EGK-722	14
	00-07				SWITCH DE STOP	EGK-730	15
GOLF A4 GTI	00-03	1.8	4	MPFI	4 TERMINALES	EGK-722	14
	00-05				SWITCH DE STOP	EGK-730	16
GOLF A4 R32	2004	3.2	6	MPFI	4 TERMINALES	EGK-722	14
GOLF A7 GTI	15-21	2.0	4	MPFI	4 TERMINALES	EGK-722	14
GOLF A7 R / TURBO	18-19	2.0	4	MPFI	4 TERMINALES	EGK-722	14
GOLF A7 SPORT WAGEN	2019	1.4	4	MPFI	4 TERMINALES	EGK-722	14
GOLF A7 TURBO	15-21	1.4	4	MPFI	4 TERMINALES	EGK-722	14
JETTA A2	87-92	1.8	4	MPFI	SWITCH DE STOP	EGK-730	15
JETTA A3	93-98	2.0	4	MPFI	SWITCH DE STOP	EGK-730	15
	93-99						
	1999	1.8			4 TERMINALES	EGK-722	14
JETTA A3 VR6	95-99	2.8	6	MPFI	SWITCH DE STOP	EGK-730	15
JETTA A4	99-02	2.0	4	MPFI	SWITCH DE STOP	EGK-730	15
	99-06				4 TERMINALES	EGK-722	14
JETTA A4 CLASICO	10-15	2.0	4	MPFI	4 TERMINALES	EGK-722	14
JETTA A4 CLASICO / GLI	11-12	1.8	4	MPFI	4 TERMINALES	EGK-722	14
JETTA A4 CLASICO / TDI	11-13	1.9	4	MPFI	4 TERMINALES	EGK-722	14

BULBO DE FRENO

VOLKSWAGEN

MODELO	AÑO	LTS.	CIL.	MODO DE INYECCIÓN	CARACTERÍSTICAS	NO. DE PARTE	
JETTA A4 TDI	99-02	1.9	4	MPFI	SWITCH DE STOP	EGK-730	15
	2006				4 TERMINALES	EGK-722	14
JETTA A4 TURBO	99-02	1.8	4	MPFI	SWITCH DE STOP	EGK-730	15
	99-05				4 TERMINALES	EGK-722	14
JETTA A4 VR6	99-02	2.8	6	MPFI	SWITCH DE STOP	EGK-730	15
	02-04				4 TERMINALES	EGK-722	14
	99-01						
PASSAT	91-93	2.0	4	MPFI	SWITCH DE STOP	EGK-730	15
POINTER	98-02	1.8	4	MPFI	4 TERMINALES	EGK-722	14
	00-02	2.0			SWITCH DE STOP	EGK-730	15
POINTER GTI	00-02	2.0	4	MPFI	4 TERMINALES	EGK-722	14
POINTER PICK UP	99-02	1.8	4	MPFI	4 TERMINALES	EGK-722	14
POINTER TRUCK	99-02	1.8	4	MPFI	SWITCH DE STOP	EGK-730	15
SHARAN TURBO	02-08	1.8	4	MPFI	4 TERMINALES	EGK-722	14
TOUAREG	04-05	3.2	6	MPFI	4 TERMINALES	EGK-722	14
		4.2	8				

BULBO DE FRENO



EGK-704



EGK-705



EGK-706



EGK-707



EGK-708



EGK-709



EGK-710



EGK-711



EGK-712



EGK-713



EGK-714



EGK-715

BULBO DE FRENO



EGK-716



EGK-717

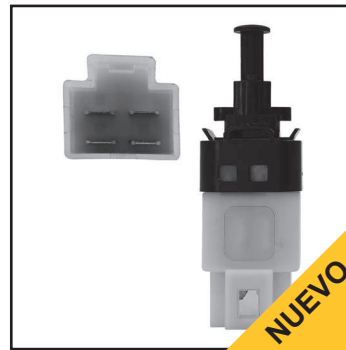

EGK-718



EGK-719



EGK-720

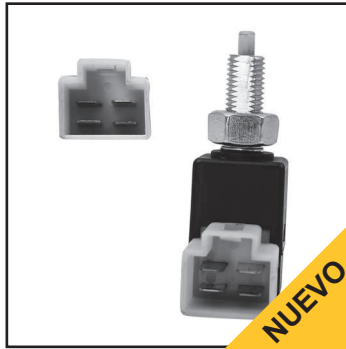

EGK-721



EGK-722



EGK-723



EGK-724



EGK-725



EGK-726

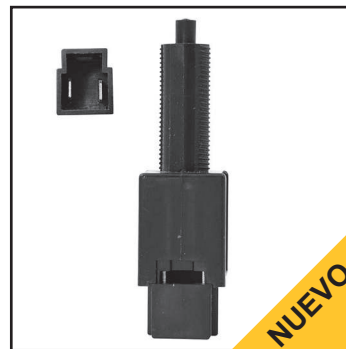

EGK-727

BULBO DE FRENO



EGK-728



EGK-729



EGK-730



BULBO DE MOTOVENTILADOR**AUDI**

MODELO	AÑO	LTS.	CIL.	MODO DE INYECCIÓN	CARACTERÍSTICAS	NO. DE PARTE	
A4	2002	3.0	6	MPFI	(TEMP 95-102°C)	BK-5605	26
					(TEMP 75-82°C)	BK-5608	
					(TEMP 85-95°C)	BK-5609	
	97-01	2.8	6	MPFI	4 TERMINALES	BK-5616	27
					(TEMP 95-102°C)	BK-5605	26
					(TEMP 75-82°C)	BK-5608	
				(TEMP 85-95°C)	BK-5609		
A4 TURBO	97-02	1.8	4	MPFI	(TEMP 95-102°C)	BK-5605	26
					(TEMP 75-82°C)	BK-5608	
					(TEMP 85-95°C)	BK-5609	

BUICK

MODELO	AÑO	LTS.	CIL.	MODO DE INYECCIÓN	CARACTERÍSTICAS	NO. DE PARTE	
CENTURY	1983	2.8	6	CARBURADO	(TEMP 100-110°C)	BK-5311	25

CHEVROLET

MODELO	AÑO	LTS.	CIL.	MODO DE INYECCIÓN	CARACTERÍSTICAS	NO. DE PARTE	
CELEBRITY	82-83	2.8	6	CARBURADO	(TEMP 100-110°C)	BK-5311	25
	82-86				(TEMP 110-118°C)	BK-5314	
	82-88				(TEMP 108-114°C)	BK-5312	
					(TEMP 107-113°C)	BK-5313	
CHEVY	94-95	1.4	4	MPFI	(TEMP 95-100°C)	BK-5330	25
	96-00	1.6		TBI			
				MPFI			
CHEVY MONZA	96-00	1.6	4	MPFI	(TEMP 95-100°C)	BK-5330	25
				TBI			
CITATION II	1985	2.8	6	CARBURADO	(TEMP 100-110°C)	BK-5311	25

CHRYSLER

MODELO	AÑO	LTS.	CIL.	MODO DE INYECCIÓN	CARACTERÍSTICAS	NO. DE PARTE	
LEBARON K	1986	2.2	4	MPFI	CONECTOR DE 2 TERMINALES	BK-5106	25
	83-87				(TEMP 85-95°C)	BK-5105	
NEW YORKER K	85-89	2.2	4	CARBURADO	(TEMP 85-95°C)	BK-5105	25
PHANTOM TURBO	87-89	2.2	4	MPFI	(TEMP 85-95°C)	BK-5105	25
VOLARE K	86-88	2.2	4	CARBURADO	CONECTOR DE 2 TERMINALES	BK-5106	25

BULBO DE MOTOVENTILADOR

DODGE

MODELO	AÑO	LTS.	CIL.	MODO DE INYECCIÓN	CARACTERÍSTICAS	NO. DE PARTE	
DART E	1989	2.2	4	CARBURADO	CONECTOR DE 2 TERMINALES	BK-5106	25
DART K	82-88	1.4	4	CARBURADO	(TEMP 85-95°C)	BK-5105	25
		1.6			CONECTOR DE 2 TERMINALES	BK-5106	
	86-88	2.2					
MAGNUM K	87-88	2.2	4	MPFI	(TEMP 85-95°C)	BK-5105	25

FORD

MODELO	AÑO	LTS.	CIL.	MODO DE INYECCIÓN	CARACTERÍSTICAS	NO. DE PARTE	
AEROSTAR	91-93	3.0	6	MPFI	(TEMP 93-105°C)	BK-5373	25
	93-95	4.0					
COUGAR	94-95	4.6	8	MPFI	(TEMP 93-105°C)	BK-5373	25
COUGAR XR7	90-94	3.8	6	MPFI	(TEMP 93-105°C)	BK-5373	25
ECONOLINE E-150	95-96	4.9	6	MPFI	(TEMP 93-105°C)	BK-5373	25
ESCORT	1994	1.9	4	MPFI	(TEMP 93-105°C)	BK-5373	25
EXPLORER	1996	5.0	8	MPFI	(TEMP 93-105°C)	BK-5373	25
	91-96	4.0	6				
F-250	92-97	5.0	8	MPFI	(TEMP 93-105°C)	BK-5373	25
		5.8					
F-350	87-97	5.8	8	MPFI	(TEMP 93-105°C)	BK-5373	25
GRAND MARQUIS	81-84	5.0	8	TBI	(TEMP 93-105°C)	BK-5373	25
	92-95	4.6		MPFI			
MAVERICK	70-77	5.0	8	CARBURADO	(TEMP 93-105°C)	BK-5373	25
MUSTANG	66-68	4.7	8	CARBURADO	(TEMP 93-105°C)	BK-5373	25
	68-73	5.0					
	94-95			4.6			
	96-97						
RANGER	1996	3.0	6	MPFI	(TEMP 93-105°C)	BK-5373	25
THUNDERBIRD	85-91	3.8	6	MPFI	(TEMP 93-105°C)	BK-5373	25
	91-93	5.0	8				
	94-96	4.6					
TOPAZ	84-91	2.3	4	MPFI	(TEMP 93-105°C)	BK-5373	25
	84-94				(TEMP 83-96°C)	BK-5390	26
WINDSTAR	95-96	3.8	6	MPFI	(TEMP 93-105°C)	BK-5373	25

BULBO DE MOTOVENTILADOR**HONDA**

MODELO	AÑO	LTS.	CIL.	MODO DE INYECCIÓN	CARACTERÍSTICAS	NO. DE PARTE	
ACCORD	03-04	2.4	4	MPFI	2 TERMINALES	BK-RF60	27
	98-04	3.0	6				
CIVIC	01-05	1.7	4	MPFI	2 TERMINALES	BK-RF60	27
	96-00	1.6					
CR-V	02-06	2.4	4	MPFI	2 TERMINALES	BK-RF60	27
ODYSSEY	00-04	3.5	6	MPFI	2 TERMINALES	BK-RF60	27
PILOT	03-04	3.5	6	MPFI	2 TERMINALES	BK-RF60	27

LINCOLN

MODELO	AÑO	LTS.	CIL.	MODO DE INYECCIÓN	CARACTERÍSTICAS	NO. DE PARTE	
TOWN CAR	91-95	4.6	8	MPFI	(TEMP 93-105°C)	BK-5373	25

MERCURY

MODELO	AÑO	LTS.	CIL.	MODO DE INYECCIÓN	CARACTERÍSTICAS	NO. DE PARTE	
SABLE	94-95	3.8	6	MPFI	(TEMP 93-105°C)	BK-5373	25

NISSAN

MODELO	AÑO	LTS.	CIL.	MODO DE INYECCIÓN	CARACTERÍSTICAS	NO. DE PARTE		
SENTRA	1992	1.6	4	MPFI	(TEMP 90-95°C)	BK-5055	24	
TSURU I	1987	1.6	4	CARBURADO	(TEMP 87-92°C)	BK-5060	24	
					(TEMP 80-85°C)	BK-5065	25	
	(TEMP 82-92°C)	BK-5056			24			
	(TEMP 77-87°C)	BK-5061						
	84-85				1.5	CONECTOR DE 2 TERMINALES	BK-5067	25
						(TEMP 95-102°C)	BK-5057	24
	86-87				1.6	(TEMP 88-95°C)	BK-5062	25
						(TEMP 77-87°C)	BK-5063	
CONECTOR DE 2 TERMINALES			BK-5067					
TSURU II	1988	1.6	4	CARBURADO	(TEMP 87-92°C)	BK-5060	24	
					(TEMP 80-85°C)	BK-5065	25	
	88-90				(TEMP 87-92°C)	BK-5059	24	
					(TEMP 80-85°C)	BK-5064	25	
	88-92				CONECTOR DE 2 TERMINALES	BK-5067		

BULBO DE MOTOVENTILADOR

SEAT

MODELO	AÑO	LTS.	CIL.	MODO DE INYECCIÓN	CARACTERÍSTICAS	NO. DE PARTE	
CORDOBA	01-03	1.6	4	MPFI	(TEMP 90-97°C)	BK-5611	26
					(TEMP 87-92°C)	BK-5612	
					(TEMP 95-102°C)	BK-5613	
IBIZA	01-02	1.6	4	MPFI	(TEMP 90-97°C)	BK-5611	26
					(TEMP 87-92°C)	BK-5612	
					(TEMP 95-102°C)	BK-5613	
IBIZA TURBO	13-17	1.2	4	MPFI	CONECTOR TRIANGULAR	BK-5029	24

VOLKSWAGEN

MODELO	AÑO	LTS.	CIL.	MODO DE INYECCIÓN	CARACTERÍSTICAS	NO. DE PARTE	
ATLANTIC	1981	1.6	4	CARBURADO	(TEMP 70-75°C)	BK-5000	24
					(TEMP 68-82°C)	BK-5610	26
					(TEMP 98-103°C)	BK-5614	26
	82-87	1.7	4	CARBURADO	(TEMP 77-82°C)	BK-5615	26
					(TEMP 70-75°C)	BK-5000	24
					(TEMP 68-82°C)	BK-5610	26
ATLANTIC GLS	84-87	1.8	4	CARBURADO	(TEMP 98-103°C)	BK-5614	26
					(TEMP 77-82°C)	BK-5615	24
					(TEMP 70-75°C)	BK-5000	24
					(TEMP 68-82°C)	BK-5610	26
BEETLE	06-08	2.5	5	MPFI	CONECTOR TRIANGULAR	BK-5029	24
	98-01	2.0	4		(TEMP 90-97°C)	BK-5611	26
					(TEMP 87-92°C)	BK-5612	
					(TEMP 95-102°C)	BK-5613	
98-08	2.0	4	CONECTOR TRIANGULAR	BK-5029	24		
BEETLE TURBO	00-01	1.8	4	MPFI	(TEMP 90-97°C)	BK-5611	26
					(TEMP 87-92°C)	BK-5612	
					(TEMP 95-102°C)	BK-5613	
	99-05	1.8	4	CONECTOR TRIANGULAR	BK-5029	24	
CARIBE	81-87	1.7	4	CARBURADO	(TEMP 70-75°C)	BK-5000	24
					(TEMP 68-82°C)	BK-5610	26
					(TEMP 98-103°C)	BK-5614	
					(TEMP 77-82°C)	BK-5615	
CARIBE GT	84-86	1.8	4	CARBURADO	(TEMP 70-75°C)	BK-5000	24
					(TEMP 68-82°C)	BK-5610	26
					(TEMP 98-103°C)	BK-5614	
					(TEMP 77-82°C)	BK-5615	
DERBY	95-97	1.8	4	MPFI	(TEMP 84-95°C)	BK-5027	24
					(TEMP 70-75°C)	BK-5028	

BULBO DE MOTOVENTILADOR**VOLKSWAGEN**

MODELO	AÑO	LTS.	CIL.	MODO DE INYECCIÓN	CARACTERÍSTICAS	NO. DE PARTE	
GOLF A2	87-92	1.8	4	CARBURADO	(TEMP 70-75°C)	BK-5000	24
				MPFI	(TEMP 95-102°C)	BK-5605	26
	CARBURADO				(TEMP 75-82°C)	BK-5608	
				(TEMP 85-95°C)	BK-5609		
				(TEMP 68-82°C)	BK-5610		
				(TEMP 98-103°C)	BK-5614		
	88-92	2.0	MPFI	(TEMP 77-82°C)	BK-5615	24	
				(TEMP 84-95°C)	BK-5027		
	90-92	2.0	MPFI	(TEMP 70-75°C)	BK-5028	26	
				(TEMP 95-102°C)	BK-5605		
(TEMP 75-82°C)				BK-5608			
GOLF A3	93-94	2.0	4	MPFI	(TEMP 85-95°C)	BK-5609	26
					(TEMP 70-75°C)	BK-5000	
					(TEMP 95-102°C)	BK-5605	
	93-97	1.8			(TEMP 75-82°C)	BK-5608	26
					(TEMP 85-95°C)	BK-5609	
					(TEMP 68-82°C)	BK-5610	
					(TEMP 90-97°C)	BK-5611	
					(TEMP 87-92°C)	BK-5612	
					(TEMP 95-102°C)	BK-5613	
	93-99	2.0			(TEMP 90-97°C)	BK-5611	24
					(TEMP 87-92°C)	BK-5612	
					(TEMP 95-102°C)	BK-5613	
					CONECTOR TRIANGULAR	BK-5029	
					CONECTOR TRIANGULAR	BK-5029	
GOLF A3 VR6	95-99	2.8	6	MPFI	(TEMP 90-97°C)	BK-5611	26
					(TEMP 87-92°C)	BK-5612	
					(TEMP 95-102°C)	BK-5613	
	98-99				CONECTOR TRIANGULAR	BK-5029	24
GOLF A4	00-01	2.0	4	MPFI	(TEMP 90-97°C)	BK-5611	26
					(TEMP 87-92°C)	BK-5612	
					(TEMP 95-102°C)	BK-5613	
	00-03				CONECTOR TRIANGULAR	BK-5029	24
GOLF A4 GTI	00-01	1.8	4	MPFI	(TEMP 90-97°C)	BK-5611	26
					(TEMP 87-92°C)	BK-5612	
					(TEMP 95-102°C)	BK-5613	
	02-05				CONECTOR TRIANGULAR	BK-5029	24
GOLF A4 R32	2004	3.2	6	MPFI	CONECTOR TRIANGULAR	BK-5029	24
JETTA A2	87-92	1.8	4	CARBURADO	(TEMP 70-75°C)	BK-5000	24
				MPFI	(TEMP 95-102°C)	BK-5605	26
					CARBURADO	(TEMP 75-82°C)	
				(TEMP 85-95°C)		BK-5609	
				(TEMP 68-82°C)		BK-5610	
				(TEMP 98-103°C)		BK-5614	
	88-92	2.0	MPFI	(TEMP 77-82°C)	BK-5615	24	
				(TEMP 84-95°C)	BK-5027		
				(TEMP 70-75°C)	BK-5028		
				(TEMP 70-75°C)	BK-5028		

BULBO DE MOTOVENTILADOR

VOLKSWAGEN

MODELO	AÑO	LTS.	CIL.	MODO DE INYECCIÓN	CARACTERÍSTICAS	NO. DE PARTE	
JETTA A3	93-97	1.8	4	MPFI	(TEMP 70-75°C)	BK-5000	24
					(TEMP 95-102°C)	BK-5605	
					(TEMP 75-82°C)	BK-5608	
					(TEMP 85-95°C)	BK-5609	
					(TEMP 68-82°C)	BK-5610	
	93-98	2.0	4	MPFI	(TEMP 90-97°C)	BK-5611	
					(TEMP 87-92°C)	BK-5612	
					(TEMP 95-102°C)	BK-5613	
					(TEMP 90-97°C)	BK-5611	
					(TEMP 87-92°C)	BK-5612	
				(TEMP 95-102°C)	BK-5613		
JETTA A3 VR6	95-98	2.8	6	MPFI	(TEMP 90-97°C)	BK-5611	26
					(TEMP 87-92°C)	BK-5612	
					(TEMP 95-102°C)	BK-5613	
JETTA A4	02-10	2.0	4	MPFI	CONECTOR TRIANGULAR	BK-5029	24
	99-01				(TEMP 90-97°C)	BK-5611	26
					(TEMP 87-92°C)	BK-5612	
					(TEMP 95-102°C)	BK-5613	
JETTA A4 CITY	08-09	2.0	4	MPFI	CONECTOR TRIANGULAR	BK-5029	24
JETTA A4 CLASICO	10-15	2.0	4	MPFI	CONECTOR TRIANGULAR	BK-5029	24
JETTA A4 TDI	06-10	1.9	4	MPFI	CONECTOR TRIANGULAR	BK-5029	24
JETTA A4 TURBO	02-05	1.8	4	MPFI	CONECTOR TRIANGULAR	BK-5029	24
	99-01				(TEMP 90-97°C)	BK-5611	26
					(TEMP 87-92°C)	BK-5612	
					(TEMP 95-102°C)	BK-5613	
JETTA A4 VR6	99-01	2.8	6	MPFI	(TEMP 90-97°C)	BK-5611	26
					(TEMP 87-92°C)	BK-5612	
					(TEMP 95-102°C)	BK-5613	
	99-04				CONECTOR TRIANGULAR	BK-5029	24
JETTA A6	11-12	2.5	5	MPFI	CONECTOR TRIANGULAR	BK-5029	24
PASSAT	03-04	4.0	8	MPFI	4 TERMINALES	BK-5616	27
	91-93	2.0	4		(TEMP 95-102°C)	BK-5605	26
					(TEMP 75-82°C)	BK-5608	
					(TEMP 85-95°C)	BK-5609	
99-05	2.8	6	4 TERMINALES	BK-5616	27		
PASSAT TURBO	98-01	1.8	4	MPFI	(TEMP 95-102°C)	BK-5605	26
					(TEMP 75-82°C)	BK-5608	
					(TEMP 85-95°C)	BK-5609	
	99-05				4 TERMINALES	BK-5616	27
PASSAT VR6	95-97	2.8	6	MPFI	(TEMP 90-97°C)	BK-5611	26
					(TEMP 87-92°C)	BK-5612	
					(TEMP 95-102°C)	BK-5613	
	99-01	(TEMP 95-102°C)	BK-5605				
		(TEMP 75-82°C)	BK-5608				
		(TEMP 85-95°C)	BK-5609				

BULBO DE MOTOVENTILADOR**VOLKSWAGEN**

MODELO	AÑO	LTS.	CIL.	MODO DE INYECCIÓN	CARACTERÍSTICAS	NO. DE PARTE	
POINTER	98-03	1.8	4	MPFI	(TEMP 81-92°C)	BK-5606	26
					(TEMP 95-100°C)	BK-5607	
POINTER PICK UP	99-03	1.8	4	MPFI	(TEMP 81-92°C)	BK-5606	26
					(TEMP 95-100°C)	BK-5607	
POINTER WAGON	99-03	1.8	4	MPFI	(TEMP 81-92°C)	BK-5606	26
					(TEMP 95-100°C)	BK-5607	
POLO	03-07	1.6	4	MPFI	CONECTOR TRIANGULAR	BK-5029	24
SHARAN TURBO	03-04	1.8	4	MPFI	(TEMP 55-63°C)	BK-5030	24
TOUAREG	04-05	4.2	8	MPFI	CONECTOR TRIANGULAR	BK-5029	24

BULBO DE MOTOVENTILADOR



BK-5000



BK-5027



BK-5028



BK-5029



BK-5030



BK-5055



BK-5056



BK-5057



BK-5059



BK-5060



BK-5061



BK-5062

BULBO DE MOTOVENTILADOR



BK-5063



BK-5064



BK-5065



BK-5067



BK-5105



BK-5106



BK-5311



BK-5312



BK-5313



BK-5314



BK-5330



BK-5373

BULBO DE MOTOVENTILADOR



BK-5390



BK-5605



BK-5606



BK-5607



BK-5608



BK-5609



BK-5610



BK-5611



BK-5612



BK-5613



BK-5614



BK-5615

BULBO DE MOTOVENTILADOR



BK-5616



BK-RF60



BULBO DE PRESIÓN DE ACEITE

AUDI

MODELO	AÑO	LTS.	CIL.	MODO DE INYECCIÓN	CARACTERÍSTICAS	NO. DE PARTE	
A1 TURBO	16-17	1.8	4	MPFI	INDICADOR DE LUZ, 1 TERMINAL	PS515	64
A3	06-07	2.0	4	MPFI	INDICADOR DE LUZ, 2 TERMINALES	PS363	63
	10-11				INDICADOR DE LUZ, 1 TERMINAL	PS518	65
A3 TURBO	10-13	2.0	4	MPFI	INDICADOR DE LUZ, 1 TERMINAL	PS518	65
	2013	1.4				PS365	63
		1.8				PS515	64
	2015	2.0				PS518	65
A4	02-05	3.0	6	MPFI	INDICADOR DE LUZ, 1 TERMINAL	PS365	63
	97-98	2.8				PS122	59
A4 ALLROAD TURBO	2013	2.0	4	MPFI	INDICADOR DE LUZ, 1 TERMINAL	PS518	65
A4 TURBO	1997	1.8	4	MPFI	INDICADOR DE LUZ, 1 TERMINAL	PS122	59
	00-08					PS365	63
	06-08	2.0			INDICADOR DE LUZ, 2 TERMINALES	PS363	63
	10-15				INDICADOR DE LUZ, 1 TERMINAL	PS518	65
	11-15	1.8			INDICADOR DE LUZ, 1 TERMINAL	PS515	64
	12-16	2.0					
A4 QUATTRO	10-12	3.2	6	MPFI	INDICADOR DE LUZ, 1 TERMINAL	PS518	65
A4 QUATTRO TURBO	10-19	2.0	4	MPFI	INDICADOR DE LUZ, 1 TERMINAL	PS518	65
A5 TURBO	2010	2.0	4	MPFI	INDICADOR DE LUZ, 1 TERMINAL	PS518	65
A5 QUATTRO TURBO	2010	2.0	4	MPFI	INDICADOR DE LUZ, 1 TERMINAL	PS518	65
	14-15						

BUICK

MODELO	AÑO	LTS.	CIL.	MODO DE INYECCIÓN	CARACTERÍSTICAS	NO. DE PARTE	
CENTURY	1986	2.8	6	CARBURADO	INDICADOR DE LUZ Y AGUJA, 3 TERMINALES	PS181	60
	1987			MPFI	INDICADOR DE LUZ, 1 TERMINAL	PS177	
	84-86			CARBURADO	INDICADOR DE LUZ, 2 TERMINALES	PS79	58
	87-88			MPFI	INDICADOR DE LUZ Y AGUJA, 3 TERMINALES	PS181	60
	94-96	3.1		INDICADOR DE LUZ, 3 TERMINALES	PS154		
ENCLAVE	10-17	3.6	6	MPFI	INDICADOR DE LUZ, 2 TERMINALES	PS269	62
ENCORE TURBO	2014	1.4	4	MPFI	INDICADOR DE LUZ, 1 TERMINAL	PS213	61
	16-19				INDICADOR DE LUZ, 3 TERMINALES	PS523	65
ENCORE GX TURBO	20-21	1.3	3	MPFI	INDICADOR DE LUZ, 3 TERMINALES	PS523	65
LACROSSE	10-16	3.6	6	MPFI	INDICADOR DE LUZ, 2 TERMINALES	PS269	62
REGAL TURBO	2013	2.0	4	MPFI	INDICADOR DE LUZ, 1 TERMINAL	PS505	64

BULBO DE PRESIÓN DE ACEITE

CADILLAC

MODELO	AÑO	LTS.	CIL.	MODO DE INYECCIÓN	CARACTERÍSTICAS	NO. DE PARTE		
ATS TURBO	2016	3.6	6	MPFI	INDICADOR DE LUZ, 3 TERMINALES	PS523	65	
	16-19	2.0	4					
	18-19	3.6	6					
CATERA	97-01	3.0	6	MPFI	INDICADOR DE LUZ, 1 TERMINAL	PS261	62	
CTS	2003	3.2	6	MPFI	INDICADOR DE LUZ, 1 TERMINAL	PS261	62	
	04-05	3.6			SENSOR DE PRESIÓN, 3 TERMINALES	PS264		
	16-19				INDICADOR DE LUZ, 3 TERMINALES	PS523	65	
CTS SC	2016	6.2	8	MPFI		PS516	65	
	12-14							
CTS TURBO	16-19	2.0	4	MPFI	INDICADOR DE LUZ, 3 TERMINALES	PS523	65	
ESCALADE	2002	6.0	8	MPFI	SENSOR DE PRESIÓN, 3 TERMINALES	PS264	62	
	02-05	5.3						
	07-08	6.2					PS516	65
	09-14							
	10-14							
ESCALADE ESV	03-06	6.0	8	MPFI	SENSOR DE PRESIÓN, 3 TERMINALES	PS264	62	
	07-08	6.2						
	09-14				INDICADOR DE LUZ, 3 TERMINALES	PS523	65	
	15-20							
ESCALADE EXT	03-06	6.0	8	MPFI	SENSOR DE PRESIÓN, 3 TERMINALES	PS264	62	
	07-08	6.2						
	09-13					PS516	65	
ESCALADE TDI	15-20	6.2	8	MPFI	INDICADOR DE LUZ, 3 TERMINALES	PS523	65	
SEVILLE	03-04	4.6	8	MPFI	INDICADOR DE LUZ, 1 TERMINAL	PS261	62	
XT4 TURBO	19-20	2.0	4	MPFI	INDICADOR DE LUZ, 3 TERMINALES	PS523	65	
XT5	17-21	3.6	6	MPFI	INDICADOR DE LUZ, 3 TERMINALES	PS523	65	

CHEVROLET

MODELO	AÑO	LTS.	CIL.	MODO DE INYECCIÓN	CARACTERÍSTICAS	NO. DE PARTE	
ASTRA	2008	1.8	4	MPFI	INDICADOR DE LUZ, 1 TERMINAL	PS261	62
	00-03						
	04-05	2.0					
AVALANCHE	2002	5.3	8	MPFI	MEDIDOR, 1 TERMINAL	PS237	62
					INDICADOR DE LUZ, 1 TERMINAL	PS238	
					SENSOR DE PRESIÓN, 3 TERMINALES	PS264	
	03-08					PS516	65
AVEO	08-18	1.6	4	MPFI	INDICADOR DE LUZ, 1 TERMINAL	PS261	62
	09-11					PS213	61
	18-23	1.5				PS525	65

BULBO DE PRESIÓN DE ACEITE

CHEVROLET

MODELO	AÑO	LTS.	CIL.	MODO DE INYECCIÓN	CARACTERÍSTICAS	NO. DE PARTE	
BLAZER	95-98	4.3	6	MPFI	INDICADOR DE LUZ Y AGUJA, 3 TERMINALES	PS185	61
	97-01				INDICADOR DE AGUJA, 1 TERMINAL	PS161	60
	19-21	3.6			INDICADOR DE LUZ, 3 TERMINALES	PS523	65
C20	1986	5.7	8	CARBURADO	INDICADOR DE LUZ, 2 TERMINALES	PS77	58
C25	1977	4.1	6	CARBURADO	INDICADOR DE AGUJA, 1 TERMINAL	PS104	59
		4.8					
C2500	1990	5.7	8	TBI	INDICADOR DE LUZ, 3 TERMINALES	PS154	60
	1999			MPFI	INDICADOR DE LUZ, 1 TERMINAL	PS238	62
	90-98				INDICADOR DE LUZ Y AGUJA, 3 TERMINALES	PS185	61
	98-00				INDICADOR DE AGUJA, 1 TERMINAL	PS161	60
					INDICADOR DE LUZ Y AGUJA, 3 TERMINALES	PS162	
C35	1977	4.8	6	CARBURADO	INDICADOR DE AGUJA, 1 TERMINAL	PS104	59
		6.6	8				
C3500	1986	5.7	8	CARBURADO	INDICADOR DE LUZ, 2 TERMINALES	PS77	58
	1990			TBI	INDICADOR DE LUZ, 3 TERMINALES	PS154	60
	1999			MPFI	INDICADOR DE LUZ, 1 TERMINAL	PS238	62
	88-89			TBI		INDICADOR DE LUZ, 2 TERMINALES	PS139
	92-98			MPFI	INDICADOR DE LUZ Y AGUJA, 3 TERMINALES	PS77	58
	99-00					PS185	61
					PS162	60	
CAMARO	95-97	5.7	8	MPFI	INDICADOR DE LUZ Y AGUJA, 3 TERMINALES	PS165	60
	99-02				MEDIDOR, 1 TERMINAL	PS237	62
	12-21	6.2			INDICADOR DE LUZ, 3 TERMINALES	PS523	65
	16-19	3.6	6				
CAMARO SS	10-15	6.2	8	MPFI		PS516	65
CAMARO SC	13-15	6.2	8	MPFI	INDICADOR DE LUZ, 3 TERMINALES	PS523	65
	17-21						
CAMARO ZL1	13-15	6.2	8	MPFI		PS516	65
CAPRICE	80-81	5.7	8	CARBURADO	INDICADOR DE LUZ, 2 TERMINALES	PS77	58
CAVALIER	1995	2.3	4	MPFI	INDICADOR DE LUZ, 3 TERMINALES	PS154	60
	02-04	2.2			INDICADOR DE LUZ, 1 TERMINAL	PS505	64
	90-93	2.8	6		INDICADOR DE LUZ, 3 TERMINALES	PS154	60
	90-94				INDICADOR DE LUZ Y AGUJA, 3 TERMINALES	PS162	
	95-96	2.2	4		INDICADOR DE LUZ, 3 TERMINALES	PS154	60
	97-02				INDICADOR DE LUZ, 1 TERMINAL	PS211	61
CAVALIER Z24	1996	2.4	4	MPFI	INDICADOR DE LUZ, 3 TERMINALES	PS154	60
	1997				INDICADOR DE LUZ, 1 TERMINAL	PS211	61
	91-93	3.1	6		INDICADOR DE LUZ, 3 TERMINALES	PS154	60
	91-94				INDICADOR DE LUZ Y AGUJA, 3 TERMINALES	PS162	

BULBO DE PRESIÓN DE ACEITE

CHEVROLET

MODELO	AÑO	LTS.	CIL.	MODO DE INYECCIÓN	CARACTERÍSTICAS	NO. DE PARTE		
CELEBRITY	1988	2.8	6	MPFI	INDICADOR DE LUZ Y AGUJA, 3 TERMINALES	PS181	60	
	1989				INDICADOR DE LUZ, 3 TERMINALES	PS153		
	82-86			MPFI	INDICADOR DE LUZ, 1 TERMINAL	PS72	58	
	85-86				CARBURADO	INDICADOR DE LUZ, 2 TERMINALES		PS79
	87-88			MPFI	INDICADOR DE LUZ, 1 TERMINAL	PS177	60	
	CHEVY			09-12	1.6	4	MPFI	INDICADOR DE LUZ, 1 TERMINAL
94-95		1.4	TBI					
96-03		1.6	MPFI					
CHEVY C2	04-08	1.6	4	MPFI	INDICADOR DE LUZ, 1 TERMINAL	PS261	62	
CHEVY MONZA	96-03	1.6	4	TBI	INDICADOR DE LUZ, 1 TERMINAL	PS261	62	
				MPFI				
CHEVY PICK UP	99-03	1.6	4	MPFI	INDICADOR DE LUZ, 1 TERMINAL	PS261	62	
CHEVY WAGON	00-03	1.6	4	MPFI	INDICADOR DE LUZ, 1 TERMINAL	PS261	62	
CHEYENNE	2009	5.3	8	MPFI		PS516	65	
	2017	6.2			SENSOR DE PRESIÓN, 3 TERMINALES	PS523		
	10-19	5.3			INDICADOR DE AGUJA, 1 TERMINAL			
CITATION	1982	2.8	6	CARBURADO	INDICADOR DE AGUJA, 1 TERMINAL	PS103	59	
	82-83				INDICADOR DE LUZ, 2 TERMINALES	PS79	58	
COLORADO	04-06	2.8	4	MPFI	INDICADOR DE LUZ, 2 TERMINALES	PS269	62	
		3.5	5					
	07-12	2.9	4		MPFI	INDICADOR DE LUZ, 3 TERMINALES	PS523	65
		3.7	5					
17-21	3.6	6	MPFI	INDICADOR DE LUZ, 3 TERMINALES	PS523	65		
CORSA	03-08	1.8	4	MPFI	INDICADOR DE LUZ, 1 TERMINAL	PS261	62	
CORSA HB	02-03	1.4	4	MPFI	INDICADOR DE LUZ, 1 TERMINAL	PS261	62	
CORVETTE	2008	6.2	8	MPFI	SENSOR DE PRESIÓN, 3 TERMINALES	PS264	62	
	05-07	6.0				PS516	65	
	09-13	6.2				INDICADOR DE LUZ Y AGUJA, 3 TERMINALES	PS162	60
	91-95	5.7			INDICADOR DE LUZ, 1 TERMINAL	PS177		
	91-96				SENSOR DE PRESIÓN, 3 TERMINALES	PS264	62	
	97-04	6.2			INDICADOR DE LUZ, 3 TERMINALES	PS523	65	
	16-18	6.2						
CORVETTE SC	12-13	6.2	8	MPFI		PS516	65	
	16-18				INDICADOR DE LUZ, 3 TERMINALES	PS523		
CRUZE	11-14	1.8	4	MPFI	INDICADOR DE LUZ, 1 TERMINAL	PS213	61	
	2016				INDICADOR DE LUZ, 3 TERMINALES	PS523	65	
CRUZE TURBO	2014	1.4	4	MPFI	INDICADOR DE LUZ, 1 TERMINAL	PS213	61	

BULBO DE PRESIÓN DE ACEITE**CHEVROLET**

MODELO	AÑO	LTS.	CIL.	MODO DE INYECCIÓN	CARACTERÍSTICAS	NO. DE PARTE	
CRUZE TURBO	16-19	1.4	4	MPFI	INDICADOR DE LUZ, 3 TERMINALES	PS523	65
EQUINOX	05-08	3.4	6	MPFI	INDICADOR DE LUZ, 1 TERMINAL	PS211	61
EQUINOX TURBO	2019	1.5	4	MPFI		PS516	65
	18-21				INDICADOR DE LUZ, 3 TERMINALES	PS523	
EXPRESS 1500	1998	4.3	6	MPFI	INDICADOR DE LUZ Y AGUJA, 3 TERMINALES	PS185	61
	1999					PS162	60
	03-08	5.3	8		SENSOR DE PRESIÓN, 3 TERMINALES	PS264	62
	03-10	4.3	6			PS212	61
	04-05				INDICADOR DE AGUJA, 1 TERMINAL	PS161	60
	97-02						
EXPRESS 2500	1999			5.7	8	MPFI	INDICADOR DE LUZ Y AGUJA, 3 TERMINALES
	12-13	6.0	INDICADOR DE AGUJA, 1 TERMINAL	PS516			65
	15-19			PS161			60
	96-02	5.7	INDICADOR DE LUZ Y AGUJA, 3 TERMINALES	PS185			61
	96-98						
EXPRESS 3500	1999	5.7	8	MPFI	INDICADOR DE LUZ Y AGUJA, 3 TERMINALES	PS162	60
	03-08	6.0			SENSOR DE PRESIÓN, 3 TERMINALES	PS264	62
	96-02	5.7				INDICADOR DE AGUJA, 1 TERMINAL	PS161
	96-98				INDICADOR DE LUZ Y AGUJA, 3 TERMINALES	PS185	61
EXPRESS 4500	10-16	6.0	8	MPFI		PS516	65
EXPRESS CARGO	2009	5.3	8	MPFI	INDICADOR DE LUZ, 3 TERMINALES	PS523	65
G20	1995	4.3	6	MPFI	INDICADOR DE LUZ Y AGUJA, 3 TERMINALES	PS162	60
HHR	06-09	2.4	4	MPFI	INDICADOR DE LUZ, 1 TERMINAL	PS505	64
LUMINA	1996	3.4	6	MPFI	INDICADOR DE LUZ, 3 TERMINALES	PS154	60
LUV	1998	2.2	4	MPFI	INDICADOR DE LUZ, 1 TERMINAL	PS261	62
MALIBU TURBO	16-19	1.5	4	MPFI	INDICADOR DE LUZ, 3 TERMINALES	PS523	65
		2.0					
MATIZ	11-15	1.0	4			PS526	65
MERIVA	04-08	1.8	4	MPFI	INDICADOR DE LUZ, 1 TERMINAL	PS261	62
MONTE CARLO	81-84	5.0	8	CARBURADO	INDICADOR DE LUZ, 2 TERMINALES	PS76	58
	82-84					PS77	
NOVA	1977	5.7	8	CARBURADO	INDICADOR DE LUZ, 2 TERMINALES	PS77	58
	78-87	4.1	6			PS79	
P30	92-97	5.7	8	MPFI	INDICADOR DE LUZ Y AGUJA, 3 TERMINALES	PS185	61
P30	98-99	5.7	8	TBI	INDICADOR DE AGUJA, 1 TERMINAL	PS161	60
				MPFI			

BULBO DE PRESIÓN DE ACEITE

CHEVROLET

MODELO	AÑO	LTS.	CIL.	MODO DE INYECCIÓN	CARACTERÍSTICAS	NO. DE PARTE	
S10	95-97	2.2	4	MPFI	INDICADOR DE LUZ Y AGUJA, 3 TERMINALES	PS185	61
	97-03				INDICADOR DE AGUJA, 1 TERMINAL	PS161	60
S10 MAXICAB	1991	3.1	6	TBI	INDICADOR DE LUZ Y AGUJA, 3 TERMINALES	PS165	60
SILVERADO 1500	03-13	4.3	6	MPFI	SENSOR DE PRESIÓN, 3 TERMINALES	PS212	61
	16-18				PS516	65	
	99-05				INDICADOR DE AGUJA, 1 TERMINAL	PS161	60
	14-17				INDICADOR DE LUZ, 3 TERMINALES	PS523	65
	19-20						
SILVERADO 2500	2000	5.7	8	MPFI	MEDIDOR, 1 TERMINAL	PS237	62
	11-12	5.3			PS516	65	
	11-13	4.8			MEDIDOR, 1 TERMINAL	PS237	62
	99-00	5.3			INDICADOR DE LUZ, 3 TERMINALES	PS523	65
	14-20						
SILVERADO 3500	01-02	6.0	8	MPFI	MEDIDOR, 1 TERMINAL	PS237	62
	03-07				SENSOR DE PRESIÓN, 3 TERMINALES	PS264	
SILVERADO 3500 HD	01-02	8.1	8	MPFI	INDICADOR DE AGUJA, 1 TERMINAL	PS161	60
	03-06				SENSOR DE PRESIÓN, 3 TERMINALES	PS378	63
	09-19	6.0			PS516	65	
SONIC	12-17	1.6	4	MPFI	INDICADOR DE LUZ, 1 TERMINAL	PS213	61
SONIC RS	14-16	1.4	4	MPFI	INDICADOR DE LUZ, 1 TERMINAL	PS213	61
SPARK	16-21	1.4	4	MPFI	INDICADOR DE LUZ, 3 TERMINALES	PS523	65
SUBURBAN	1987	5.7	8	TBI	INDICADOR DE LUZ, 1 TERMINAL	PS139	59
	2008	6.0		MPFI	SENSOR DE PRESIÓN, 3 TERMINALES	PS264	
	00-02	5.3			MEDIDOR, 1 TERMINAL	PS237	62
	03-06				SENSOR DE PRESIÓN, 3 TERMINALES	PS264	
	87-89	5.7		TBI	INDICADOR DE LUZ, 2 TERMINALES	PS176	60
	88-90			CARBURADO	INDICADOR DE AGUJA, 1 TERMINAL	PS384	63
	97-99				PS161	60	
	15-20	5.3		MPFI	INDICADOR DE LUZ, 3 TERMINALES	PS523	65
	16-19	6.0					
SUBURBAN 1500	09-13	6.0	8	MPFI		PS516	65
	09-14	5.3					
SUBURBAN 2500	00-02	6.0	8	MPFI	MEDIDOR, 1 TERMINAL	PS237	62
	03-08				SENSOR DE PRESIÓN, 3 TERMINALES	PS264	
TAHOE	07-08	5.3	8	MPFI	SENSOR DE PRESIÓN, 3 TERMINALES	PS264	62
	09-14				PS516	65	
	14-20				INDICADOR DE LUZ, 3 TERMINALES		PS523
TORNADO	04-11	1.8	4	MPFI	INDICADOR DE LUZ, 1 TERMINAL	PS261	62
TRACKER	1998	1.6	4	MPFI	INDICADOR DE LUZ, 1 TERMINAL	PS85	59
	02-04	2.5	6				

BULBO DE PRESIÓN DE ACEITE

CHEVROLET

MODELO	AÑO	LTS.	CIL.	MODO DE INYECCIÓN	CARACTERÍSTICAS	NO. DE PARTE	
TRAIL BLAZER	02-07	4.2	6	MPFI	INDICADOR DE LUZ, 2 TERMINALES	PS269	62
TRAIL BLAZER EXT	02-06	4.2	6	MPFI	INDICADOR DE LUZ, 2 TERMINALES	PS269	62
	03-06	5.3	8		SENSOR DE PRESIÓN, 3 TERMINALES	PS264	
TRAVERSE	09-17	3.6	6	MPFI	INDICADOR DE LUZ, 2 TERMINALES	PS269	62
TRAX	13-20	1.8	4	MPFI	INDICADOR DE LUZ, 1 TERMINAL	PS213	61
TRAX TURBO	14-15	1.4	4	MPFI	INDICADOR DE LUZ, 1 TERMINAL	PS213	61
UPLANDER	05-06	3.5	6	MPFI	INDICADOR DE LUZ, 1 TERMINAL	PS211	61
VECTRA	2003	2.2	4	MPFI	INDICADOR DE LUZ, 1 TERMINAL	PS261	62
		3.2	6				
VENTURE	97-04	3.4	6	MPFI	INDICADOR DE LUZ, 1 TERMINAL	PS211	61
VOLT HÍBRIDO	16-19	1.5	4	MPFI	INDICADOR DE LUZ, 3 TERMINALES	PS523	65
ZAFIRA	02-06	2.2	4	MPFI	INDICADOR DE LUZ, 1 TERMINAL	PS261	62

CHRYSLER

MODELO	AÑO	LTS.	CIL.	MODO DE INYECCIÓN	CARACTERÍSTICAS	NO. DE PARTE	
200	12-14	2.4	4	MPFI	INDICADOR DE LUZ, 1 TERMINAL	PS511	64
	12-16	3.6	6		SENSOR DE PRESIÓN, 3 TERMINALES	PS350	63
300	12-16	3.6	6	MPFI	SENSOR DE PRESIÓN, 3 TERMINALES	PS350	63
300 SRT-8	12-14	6.4	8	MPFI	SENSOR DE PRESIÓN, 3 TERMINALES	PS350	63
300C	05-10	3.5	6	MPFI	INDICADOR DE LUZ, 1 TERMINAL	PS254	62
	07-10	5.7	8		SENSOR DE PRESIÓN, 3 TERMINALES	PS350	63
	12-13						
300C SRT-8	07-08	6.1	8	MPFI	SENSOR DE PRESIÓN, 3 TERMINALES	PS350	63
300M	99-04	3.5	6	MPFI	INDICADOR DE LUZ, 1 TERMINAL	PS254	62
600 K	1984	2.2	4	MPFI	INDICADOR DE LUZ, 1 TERMINAL	PS382	63
	84-85					PS143	59
						PS382	63
600 K TURBO	1984	2.2	4	CARBURADO	INDICADOR DE LUZ Y AGUJA, 3 TERMINALES	PS88	58
ASPEN	07-09	5.7	8	MPFI	SENSOR DE PRESIÓN, 3 TERMINALES	PS350	63
BARRACUDA	1966	3.7	6	CARBURADO	INDICADOR DE AGUJA, 1 TERMINAL	PS91	58
	67-69	5.2	8				
CIRRUS	96-00	2.5	6	MPFI	INDICADOR DE LUZ, 1 TERMINAL	PS254	62
CIRRUS TURBO	2002	2.4	4	MPFI	INDICADOR DE LUZ, 1 TERMINAL	PS254	62
	97-00						

BULBO DE PRESIÓN DE ACEITE

CHRYSLER

MODELO	AÑO	LTS.	CIL.	MODO DE INYECCIÓN	CARACTERÍSTICAS	NO. DE PARTE	
CONCORDE	2002	3.5	6	MPFI	INDICADOR DE LUZ, 1 TERMINAL	PS254	62
	93-95					PS214	61
	96-97					PS254	62
CORDOBA	80-82	5.9	8	CARBURADO	INDICADOR DE AGUJA, 1 TERMINAL	PS91	58
DUSTER	70-76	3.7	6	CARBURADO	INDICADOR DE AGUJA, 1 TERMINAL	PS91	58
GRAND VOYAGER	91-93	3.3	6	MPFI	INDICADOR DE LUZ Y AGUJA, 2 TERMINALES	PS171	60
	94-95	3.8					
IMPERIAL	1991	3.3	6	MPFI	INDICADOR DE LUZ Y AGUJA, 2 TERMINALES	PS171	60
LEBARON	1979	5.9	8	CARBURADO	INDICADOR DE LUZ Y AGUJA, 3 TERMINALES	PS87	59
	78-81				INDICADOR DE AGUJA, 1 TERMINAL	PS91	58
LEBARON K	1987	2.2	4	MPFI	INDICADOR DE LUZ, 1 TERMINAL	PS14	58
	83-84			CARBURADO	INDICADOR DE LUZ Y AGUJA, 3 TERMINALES	PS88	
	84-85			MPFI	INDICADOR DE LUZ, 1 TERMINAL	PS382	63
	84-87					PS143	59
	86-87					PS382	63
			INDICADOR DE LUZ Y AGUJA, 3 TERMINALES	PS87	59		
LEBARON TURBO	1992	2.5	4	MPFI	INDICADOR DE LUZ Y AGUJA, 2 TERMINALES	PS170	60
LHS	96-97	3.5	6	MPFI	INDICADOR DE LUZ, 1 TERMINAL	PS254	62
NEW YORKER	92-93	3.3	6	MPFI	INDICADOR DE LUZ Y AGUJA, 2 TERMINALES	PS171	60
NEW YORKER K	1989	2.2	4	MPFI	INDICADOR DE LUZ Y AGUJA, 2 TERMINALES	PS167	60
	84-88					PS143	59
	85-88				INDICADOR DE LUZ, 1 TERMINAL	PS382	63
	87-88					PS14	58
NEW YORKER LH	94-95	3.5	6	MPFI	INDICADOR DE LUZ, 1 TERMINAL	PS214	61
NEW YORKER TURBO	1985	2.2	4	MPFI	INDICADOR DE LUZ, 1 TERMINAL	PS72	58
	85-86				INDICADOR DE LUZ Y AGUJA, 3 TERMINALES	PS87	59
	92-93	2.5			INDICADOR DE LUZ Y AGUJA, 2 TERMINALES	PS171	60
PACIFICA	2008	4.0	6	MPFI	INDICADOR DE LUZ, 1 TERMINAL	PS254	62
	04-06	3.5					
PT CRUISER	01-10	2.4	4	MPFI	INDICADOR DE LUZ, 1 TERMINAL	PS254	62
SUPER BEE	70-76	5.2	8	CARBURADO	INDICADOR DE AGUJA, 1 TERMINAL	PS91	58
TOWN & COUNTRY	1993	3.3	6	MPFI	INDICADOR DE LUZ Y AGUJA, 2 TERMINALES	PS171	60
	08-10	4.0			INDICADOR DE LUZ, 1 TERMINAL	PS254	62
	11-16	3.6			SENSOR DE PRESIÓN, 3 TERMINALES	PS350	63

BULBO DE PRESIÓN DE ACEITE

CHRYSLER

MODELO	AÑO	LTS.	CIL.	MODO DE INYECCIÓN	CARACTERÍSTICAS	NO. DE PARTE	
TOWN & COUNTRY	94-95	3.8	6	MPFI	INDICADOR DE LUZ Y AGUJA, 2 TERMINALES	PS171	60
	96-07				INDICADOR DE LUZ, 1 TERMINAL	PS254	62
VALIANT	65-67	4.5	8	CARBURADO	INDICADOR DE AGUJA, 1 TERMINAL	PS91	58
	65-76	3.7	6				
	70-76	5.2	8				
	74-82	3.7	6		INDICADOR DE LUZ Y AGUJA, 3 TERMINALES	PS75	
VOLARE	77-80	3.7	6	CARBURADO	INDICADOR DE AGUJA, 1 TERMINAL	PS91	58
	79-80				INDICADOR DE LUZ Y AGUJA, 3 TERMINALES	PS75	
VOYAGER	00-06	3.3	6	MPFI	INDICADOR DE LUZ, 1 TERMINAL	PS254	62
	91-95				INDICADOR DE LUZ Y AGUJA, 2 TERMINALES	PS171	60
	98-99	3.8			INDICADOR DE LUZ, 1 TERMINAL	PS254	62

DODGE

MODELO	AÑO	LTS.	CIL.	MODO DE INYECCIÓN	CARACTERÍSTICAS	NO. DE PARTE	
ATTITUDE	15-23	1.2	3	MPFI	1 TERMINAL	PS517	65
ATOS	01-04	1.0	4	MPFI	INDICADOR DE LUZ, 1 TERMINAL	PS290	62
	05-12	1.1				PS361	63
AVENGER	08-09	3.5	6	MPFI	INDICADOR DE LUZ, 1 TERMINAL	PS254	62
	08-10	2.0	4			PS511	64
	08-13	2.4					
CALIBER	07-09	1.8	4	MPFI	INDICADOR DE LUZ, 1 TERMINAL	PS511	64
		2.0					
	07-12	2.4					
CALIBER SRT-4	08-09	2.4	4	MPFI	INDICADOR DE LUZ, 1 TERMINAL	PS511	64
CHALLENGER	13-16	3.6	6	MPFI	SENSOR DE PRESIÓN, 3 TERMINALES	PS350	63
CHALLENGER R/T	09-14	5.7	8	MPFI	SENSOR DE PRESIÓN, 3 TERMINALES	PS350	63
CHALLENGER SC	15-16	6.2	8	MPFI	SENSOR DE PRESIÓN, 3 TERMINALES	PS350	63
CHALLENGER SRT-8	08-10	6.1	8	MPFI	SENSOR DE PRESIÓN, 3 TERMINALES	PS350	63
	11-16	6.4					
CHARGER	06-10	3.5	6	MPFI	INDICADOR DE LUZ, 1 TERMINAL	PS254	62
	11-16	3.6			SENSOR DE PRESIÓN, 3 TERMINALES	PS350	63
CHARGER R/T	07-16	5.7	8	MPFI	SENSOR DE PRESIÓN, 3 TERMINALES	PS350	63
CHARGER SC	15-16	6.2	8	MPFI	SENSOR DE PRESIÓN, 3 TERMINALES	PS350	63
CHARGER SRT-8	07-10	6.1	8	MPFI	SENSOR DE PRESIÓN, 3 TERMINALES	PS350	63
	12-16	6.4					

BULBO DE PRESIÓN DE ACEITE

DODGE

MODELO	AÑO	LTS.	CIL.	MODO DE INYECCIÓN	CARACTERÍSTICAS	NO. DE PARTE	
D-150	1978	7.2	8	CARBURADO	INDICADOR DE AGUJA, 1 TERMINAL	PS91	58
	1989	3.7	6	TBI		PS59	
	77-78	6.6	8	CARBURADO		PS91	
	77-85	5.2					
		5.9					
	78-80	4.0	6		INDICADOR DE LUZ Y AGUJA, 3 TERMINALES	PS75	
	78-87	3.7			INDICADOR DE AGUJA, 1 TERMINAL	PS59	
	86-87				INDICADOR DE LUZ Y AGUJA, 3 TERMINALES	PS87	59
		88-90		TBI			
	92-93	5.2	8	MPFI	INDICADOR DE LUZ Y AGUJA, 2 TERMINALES	PS168	60
		5.9					
D-350	81-83	5.2	8	CARBURADO	INDICADOR DE AGUJA, 1 TERMINAL	PS91	58
	81-85	5.9					
	83-85	3.7	6				
DAKOTA	1996	2.5	4	MPFI	INDICADOR DE LUZ Y AGUJA, 2 TERMINALES	PS167	60
	2007	4.7	8		INDICADOR DE LUZ, 1 TERMINAL	PS274	62
	05-10	3.7	6				
DART	65-66	2.8	6	CARBURADO	INDICADOR DE AGUJA, 1 TERMINAL	PS91	58
	67-76	3.7					
	68-76	5.2	8		INDICADOR DE LUZ Y AGUJA, 3 TERMINALES	PS75	
	74-82	3.7	6				
DART E	1989	2.2	4	CARBURADO	INDICADOR DE LUZ Y AGUJA, 2 TERMINALES	PS170	60
DURANGO	2001	4.7	8	MPFI	INDICADOR DE AGUJA, 2 TERMINALES	PS257	62
	2002				SENSOR DE PRESIÓN, 3 TERMINALES	PS350	63
	2003	5.9			INDICADOR DE LUZ, 1 TERMINAL	PS274	62
	2009	5.7					
	03-07	4.7					
	04-05	5.7	6		SENSOR DE PRESIÓN, 3 TERMINALES	PS350	63
	04-09	5.7					
	12-13	3.6	8		INDICADOR DE AGUJA, 2 TERMINALES	PS257	62
	12-16	5.7					
98-00	5.2						
98-01	5.9						
INTREPID	1996	3.3	6	MPFI	INDICADOR DE LUZ, 1 TERMINAL	PS254	62
	1998	2.7				PS214	61
	2001	3.5					
	94-96	3.3					
	96-97	3.5				PS254	62
	98-00	3.2					
JOURNEY	09-10	3.5	6	MPFI	INDICADOR DE LUZ, 1 TERMINAL	PS254	62
	09-19	2.4	4		SENSOR DE PRESIÓN, 3 TERMINALES	PS511	64
	12-16	3.6	6			PS350	63

BULBO DE PRESIÓN DE ACEITE

DODGE

MODELO	AÑO	LTS.	CIL.	MODO DE INYECCIÓN	CARACTERÍSTICAS	NO. DE PARTE		
MAGNUM K	89-90	2.2	4	MPFI	INDICADOR DE LUZ Y AGUJA, 2 TERMINALES	PS170	60	
	89-90	2.5						
MONACO	70-77	5.2	8	CARBURADO	INDICADOR DE AGUJA, 1 TERMINAL	PS91	58	
NEON	95-96	2.0	4	MPFI	INDICADOR DE LUZ, 1 TERMINAL	PS214	61	
	96-05					PS254	62	
NEON SRT-4	04-05	2.4	4	MPFI	INDICADOR DE LUZ, 1 TERMINAL	PS254	62	
NITRO	07-10	3.7	6	MPFI	INDICADOR DE LUZ, 1 TERMINAL	PS274	62	
NITRO R/T	07-09	4.0	6	MPFI	INDICADOR DE LUZ, 1 TERMINAL	PS254	62	
RAM 1500	03-10	3.7	6	MPFI	INDICADOR DE LUZ, 1 TERMINAL	PS274	62	
	94-97	3.9			INDICADOR DE LUZ Y AGUJA, 2 TERMINALES	PS168	60	
	98-01				INDICADOR DE AGUJA, 2 TERMINALES	PS257	62	
RAM 640	2006	5.7	8	MPFI	SENSOR DE PRESIÓN, 3 TERMINALES	PS350	63	
	03-08				INDICADOR DE LUZ, 1 TERMINAL	PS274	62	
	09-10				SENSOR DE PRESIÓN, 3 TERMINALES	PS350	63	
	94-97				5.2	INDICADOR DE LUZ Y AGUJA, 2 TERMINALES	PS168	60
	98-02				5.9	INDICADOR DE AGUJA, 2 TERMINALES	PS257	62
RAM 3500	94-97	5.9	8	MPFI	INDICADOR DE LUZ Y AGUJA, 2 TERMINALES	PS168	60	
	98-02				INDICADOR DE AGUJA, 2 TERMINALES	PS257	62	
RAM VAN 1500	02-03	3.9	6	MPFI	INDICADOR DE LUZ, 1 TERMINAL	PS274	62	
	99-03				INDICADOR DE AGUJA, 2 TERMINALES	PS257		
RAM VAN 640	02-03	5.2	8	MPFI	INDICADOR DE LUZ, 1 TERMINAL	PS274	62	
	99-02				INDICADOR DE AGUJA, 2 TERMINALES	PS257		
RAM VAN 3500	02-03	5.9	8	MPFI	INDICADOR DE LUZ, 1 TERMINAL	PS274	62	
	99-01				INDICADOR DE AGUJA, 2 TERMINALES	PS257		
RAMCHARGER	86-87	5.9	8	CARBURADO	INDICADOR DE AGUJA, 1 TERMINAL	PS59	58	
				MPFI	INDICADOR DE LUZ Y AGUJA, 3 TERMINALES	PS75		
	89-90				PS87	59		
90-93	INDICADOR DE LUZ Y AGUJA, 2 TERMINALES	PS168	60					
SHADOW GTS	89-90	2.2	4	MPFI	INDICADOR DE LUZ Y AGUJA, 2 TERMINALES	PS170	60	
SHADOW TURBO	89-92	2.5	4	MPFI	INDICADOR DE LUZ Y AGUJA, 2 TERMINALES	PS170	60	
SPIRIT	89-92	2.5	4	MPFI	INDICADOR DE LUZ Y AGUJA, 2 TERMINALES	PS167	60	
SPIRIT R/T	91-92	2.5	4	MPFI	INDICADOR DE LUZ Y AGUJA, 2 TERMINALES	PS170	60	
STRATUS	1995	2.0	4	MPFI	INDICADOR DE LUZ, 1 TERMINAL	PS214	61	
		2.4						

BULBO DE PRESIÓN DE ACEITE

DODGE

MODELO	AÑO	LTS.	CIL.	MODO DE INYECCIÓN	CARACTERÍSTICAS	NO. DE PARTE	
STRATUS	01-05	2.0	4	MPFI	INDICADOR DE LUZ, 1 TERMINAL	PS85	59
	02-06	2.4				PS254	62
	96-00	2.0				PS254	62
		2.4					
STRATUS R/T	01-05	2.4	4	MPFI	INDICADOR DE LUZ, 1 TERMINAL	PS85	59
VIPER SRT-10	2010	8.4	10	MPFI	SENSOR DE PRESIÓN, 3 TERMINALES	PS350	63
	04-05	8.3					
W150	1986	3.7	6	CARBURADO	INDICADOR DE LUZ Y AGUJA, 3 TERMINALES	PS75	58

FORD

MODELO	AÑO	LTS.	CIL.	MODO DE INYECCIÓN	CARACTERÍSTICAS	NO. DE PARTE		
AEROSTAR	91-93	3.0	6	MPFI	INDICADOR DE LUZ, 1 TERMINAL	PS193	61	
	93-95	4.0				PS201		
CONTOUR	96-97	2.5	6	MPFI	INDICADOR DE LUZ, 1 TERMINAL	PS68	58	
	96-98	2.0	4			PS230	61	
						PS68	58	
	96-98	2.5	6			PS230	61	
						98-00	PS317	63
	99-00	2.0	4			PS306		
COUGAR	1988	3.8	6	MPFI	INDICADOR DE AGUJA, 1 TERMINAL	PS90	58	
	85-87			TBI	INDICADOR DE LUZ, 1 TERMINAL	PS68		
				INDICADOR DE AGUJA, 1 TERMINAL	PS90			
	90-94	4.6	8	MPFI	INDICADOR DE LUZ, 1 TERMINAL	PS201	61	
	94-95					PS68	58	
COUGAR XR7	1990	3.8	6	MPFI	INDICADOR DE LUZ, 1 TERMINAL	PS68	58	
ECONOLINE E-150	00-02	4.2	6	MPFI	INDICADOR DE LUZ, 1 TERMINAL	PS512	64	
	02-03					PS241	62	
	04-06	4.6	8			PS193	61	
	95-96	4.9	6			INDICADOR DE AGUJA, 1 TERMINAL	PS59	58
	97-98	4.2				INDICADOR DE LUZ, 1 TERMINAL	PS241	62
	97-99							
ECONOLINE E-64	02-03	4.2	6	MPFI	INDICADOR DE LUZ, 1 TERMINAL	PS241	62	
	97-99							
ECONOLINE E-350	98-03	5.4	8	MPFI	INDICADOR DE LUZ, 1 TERMINAL	PS241	62	
ECOSPORT	04-12	2.0	4	MPFI	INDICADOR DE LUZ, 1 TERMINAL	PS504	64	
	18-20	1.5	3					
		2.0	4					

BULBO DE PRESIÓN DE ACEITE**FORD**

MODELO	AÑO	LTS.	CIL.	MODO DE INYECCIÓN	CARACTERÍSTICAS	NO. DE PARTE		
EDGE	07-14	3.5	6	MPFI	INDICADOR DE LUZ, 1 TERMINAL	PS503	64	
	12-14					PS504		
EDGE TURBO	19-20	2.0	4	MPFI	INDICADOR DE LUZ, 3 TERMINALES	PS521	65	
		2.7	6					
ESCAPE	01-04	3.0	6	MPFI	INDICADOR DE LUZ, 1 TERMINAL	PS305	62	
	01-06					PS317	63	
	07-12					PS500	64	
	09-15	2.5	4			PS313	63	
	13-19					PS504	64	
ESCAPE TURBO	14-15	2.0	4	MPFI	INDICADOR DE LUZ, 1 TERMINAL	PS313	63	
	14-19					PS504	64	
ESCORT	94-96	1.9	4	MPFI	INDICADOR DE LUZ, 1 TERMINAL	PS228	61	
	98-01	2.0				PS230		
	99-01					PS305		62
ESCORT GT	94-95	1.8	4	MPFI	INDICADOR DE LUZ, 1 TERMINAL	PS85	59	
EXCURSION	01-05	6.8	10	MPFI	INDICADOR DE LUZ, 1 TERMINAL	PS241	62	
EXPEDITION	03-04	4.6	8	MPFI	INDICADOR DE AGUJA, 1 TERMINAL	PS503	64	
	03-14	5.4						
	97-04	4.6			INDICADOR DE LUZ, 1 TERMINAL	PS241	62	
	97-06	5.4						
EXPEDITION BT	15-18	3.5	6	MPFI	INDICADOR DE LUZ, 1 TERMINAL	PS503	64	
EXPLORER	1998	5.0	8	MPFI	INDICADOR DE LUZ, 1 TERMINAL	PS503	64	
	2001	4.0	6		INDICADOR DE AGUJA, 1 TERMINAL			
	01-05				4.6	8	INDICADOR DE LUZ, 1 TERMINAL	PS241
	02-05							
	06-10	4.6	8					PS503
	11-19				3.5	6		PS504
	12-15	4.0	8					PS201
	91-96				5.0	8		PS241
	96-98	INDICADOR DE AGUJA, 1 TERMINAL	PS503					64
	99-01							
EXPLORER SPORT TRAC	07-10	4.6	8	MPFI	INDICADOR DE LUZ, 1 TERMINAL	PS503		64
EXPLORER TURBO	2015	3.5	6	MPFI	INDICADOR DE LUZ, 1 TERMINAL	PS504		64
F-150	1986	3.8	6	CARBURADO	INDICADOR DE AGUJA, 1 TERMINAL	PS90	58	
	1987							
	1997	4.6	8	MPFI	INDICADOR DE LUZ, 1 TERMINAL	PS201	61	
		4.9				PS241	62	
	2003	4.2	6		PARA MEDIDOR O LAMPARA	PS512	64	
	05-08							
	05-09				INDICADOR DE LUZ, 1 TERMINAL			PS241
05-10	4.6	8						
06-08	4.2	6	INDICADOR DE AGUJA, 1 TERMINAL		PS503	64		

BULBO DE PRESIÓN DE ACEITE

FORD

MODELO	AÑO	LTS.	CIL.	MODO DE INYECCIÓN	CARACTERÍSTICAS	NO. DE PARTE		
F-150	11-14	3.7	6	MPFI	INDICADOR DE AGUJA, 1 TERMINAL	PS503	64	
		5.0	8					
	15-16	3.5	6		INDICADOR DE LUZ, 1 TERMINAL	PS193	61	
		88-89						3.8
	91-94	4.9				8	PS241	62
	95-96	4.6						
	97-99	4.2	6		INDICADOR DE LUZ, 3 TERMINALES	PS521	65	
	98-99	3.5						
	2017	5.0						8
15-20	5.0	8						
F-64	1997	5.0	8	MPFI	INDICADOR DE LUZ, 1 TERMINAL	PS241	62	
		5.8						
	2002	4.6				PS201	61	
	92-96	5.0						
	92-97	5.8				PS241	62	
	98-99	4.6						
F-350	1995	5.0	8	MPFI	INDICADOR DE LUZ, 1 TERMINAL	PS201	61	
								1997
	86-87	5.0		CARBURADO	INDICADOR DE AGUJA, 1 TERMINAL	PS90	58	
	88-97	5.8		MPFI	INDICADOR DE LUZ, 1 TERMINAL	PS201	61	
F-350 SUPER DUTY	99-06	5.4	8	MPFI	INDICADOR DE LUZ, 1 TERMINAL	PS241	62	
F-450 SUPER DUTY	03-08	6.8	10	MPFI	INDICADOR DE AGUJA, 1 TERMINAL	PS503	64	
	11-16							
F-550 SUPER DUTY	03-16	6.8	10	MPFI	INDICADOR DE AGUJA, 1 TERMINAL	PS503	64	
FAIRMONT	1980	4.2	8	CARBURADO	INDICADOR DE LUZ Y AGUJA, 3 TERMINALES	PS95	59	
	80-82				INDICADOR DE AGUJA, 1 TERMINAL	PS90	58	
FIESTA	01-06	1.6	4	MPFI	INDICADOR DE LUZ, 1 TERMINAL	PS306	63	
	11-19					PS504	64	
FIESTA IKON INDIA	12-15	1.6	4	MPFI	INDICADOR DE LUZ, 1 TERMINAL	PS504	64	
FIESTA ST	14-19	1.6	4	MPFI	INDICADOR DE LUZ, 1 TERMINAL	PS504	64	
FIGO	16-18	1.5	4	MPFI	INDICADOR DE LUZ, 1 TERMINAL	PS504	64	
	19-21		3					
FIVE HUNDRED	05-07	3.0	6	MPFI	INDICADOR DE LUZ, 1 TERMINAL	PS317	63	
FOCUS	00-04	2.0	4	MPFI	INDICADOR DE LUZ, 1 TERMINAL	PS305	62	
						PS306	63	
	05-07					PS504	64	
	08-11					PS313	63	
	12-18					PS504	64	
FOCUS RS	16-17	2.3	4	MPFI	INDICADOR DE LUZ, 1 TERMINAL	PS504	64	

BULBO DE PRESIÓN DE ACEITE**FORD**

MODELO	AÑO	LTS.	CIL.	MODO DE INYECCIÓN	CARACTERÍSTICAS	NO. DE PARTE	
FOCUS ST	2007	2.5	5	MPFI	INDICADOR DE LUZ, 1 TERMINAL	PS504	64
	08-10					PS313	63
FOCUS TURBO	13-18	2.0	4	MPFI	INDICADOR DE LUZ, 1 TERMINAL	PS504	64
FREESTAR	04-07	4.2	6	MPFI	INDICADOR DE LUZ, 1 TERMINAL	PS316	63
FUSION	06-12	3.0	6	MPFI	INDICADOR DE LUZ, 1 TERMINAL	PS500	64
	07-09	2.3				4	PS313
	10-14	2.5	PS504				64
	13-19						
FUSION HÍBRIDO	17-19	2.0	4	MPFI	INDICADOR DE LUZ, 1 TERMINAL	PS504	64
FUSION SPORT	10-12	3.5	6	MPFI	INDICADOR DE LUZ, 1 TERMINAL	PS503	64
FUSION TURBO	2014	2.0	4	MPFI	INDICADOR DE LUZ, 1 TERMINAL	PS313	63
	13-19					PS504	64
GALAXIE 500	70-71	5.8	8	CARBURADO	INDICADOR DE LUZ, 1 TERMINAL	PS68	58
	70-72				INDICADOR DE AGUJA, 1 TERMINAL	PS90	
	71-72				INDICADOR DE LUZ, 1 TERMINAL	PS66	
	73-74				INDICADOR DE LUZ, 1 TERMINAL	PS68	
GRAND MARQUIS	1982	5.0	8	CARBURADO	INDICADOR DE LUZ Y AGUJA, 3 TERMINALES	PS95	59
	00-04	4.6		MPFI	INDICADOR DE LUZ, 1 TERMINAL	PS241	62
	92-99					PS201	61
IKON	04-07	1.6	4	MPFI	INDICADOR DE LUZ, 1 TERMINAL	PS306	63
KA	01-08	1.6	4	MPFI	INDICADOR DE LUZ, 1 TERMINAL	PS306	63
LOBO	2007	4.6	8	MPFI	INDICADOR DE AGUJA, 1 TERMINAL	PS503	64
		5.4					
LTD	77-78	5.0	8	CARBURADO	INDICADOR DE LUZ, 1 TERMINAL	PS68	58
LTD CROWN VICTORIA	1981	5.0	8	CARBURADO	INDICADOR DE LUZ Y AGUJA, 3 TERMINALES	PS95	59
MUSTANG	1968	4.7	8	CARBURADO	INDICADOR DE LUZ, 1 TERMINAL	PS66	58
	1969	5.0				PS68	
	1979				INDICADOR DE LUZ Y AGUJA, 3 TERMINALES	PS95	
	1982	PS68				58	
	1999	4.6	6	MPFI	INDICADOR DE LUZ, 1 TERMINAL	PS503	64
	2010	4.0			INDICADOR DE AGUJA, 1 TERMINAL		
	2013	3.7					
	2016	5.2	8	CARBURADO	1 TERMINAL	PS90	58
	06-10	4.6			INDICADOR DE AGUJA, 1 TERMINAL		
	11-16	5.0			INDICADOR DE LUZ, 1 TERMINAL		
	65-68	4.7	5.0	INDICADOR DE AGUJA, 1 TERMINAL	PS68	PS90	58
	70-73	INDICADOR DE LUZ, 1 TERMINAL					
			5.8	INDICADOR DE AGUJA, 1 TERMINAL	PS90	PS68	58
	79-84	5.0	INDICADOR DE LUZ, 1 TERMINAL	PS90			
	94-95			MPFI	INDICADOR DE LUZ, 1 TERMINAL	PS201	61

BULBO DE PRESIÓN DE ACEITE

FORD

MODELO	AÑO	LTS.	CIL.	MODO DE INYECCIÓN	CARACTERÍSTICAS	NO. DE PARTE	
MUSTANG	96-98	4.6	8	MPFI	INDICADOR DE LUZ, 1 TERMINAL	PS201	61
	99-03					PS241	62
	99-04				1 TERMINAL	PS503	64
MUSTANG II	1974	5.0	8	CARBURADO	INDICADOR DE LUZ, 1 TERMINAL	PS68	58
RANGER	2001	3.0	6	MPFI	INDICADOR DE LUZ, 1 TERMINAL	PS313	63
	2002					PS503	64
	01-12	2.3	4			PS313	63
	96-97					PS193	61
	96-98	3.0	6			PS241	62
	99-01					PS241	62
THUNDERBIRD	1988	3.8	6	MPFI	INDICADOR DE AGUJA, 1 TERMINAL	PS90	58
	85-87			TBI			
	86-94			MPFI			
	91-94	5.0	8	MPFI	INDICADOR DE LUZ, 1 TERMINAL	PS201	61
	95-96						
WINDSTAR	01-03	3.8	6	MPFI	INDICADOR DE LUZ, 1 TERMINAL	PS316	63
	95-98					PS68	58
	99-00					PS305	62

GMC

MODELO	AÑO	LTS.	CIL.	MODO DE INYECCIÓN	CARACTERÍSTICAS	NO. DE PARTE	
ACADIA	07-16	3.6	6	MPFI	INDICADOR DE LUZ, 2 TERMINALES	PS269	62
	17-21				INDICADOR DE LUZ, 3 TERMINALES	PS523	65
CANYON	07-12	3.7	5	MPFI	INDICADOR DE LUZ, 2 TERMINALES	PS269	62
SIERRA	10-13	6.2	8	MPFI	INDICADOR DE LUZ, 3 TERMINALES	PS523	65
	10-19	5.3					
	15-16	6.2					
SIERRA 1500	09-13	5.3	8	MPFI	SENSOR DE PRESIÓN, 3 TERMINALES	PS516	65
		6.2					
SIERRA 1500 DENALI	07-08	6.2	8	MPFI	SENSOR DE PRESIÓN, 3 TERMINALES	PS264	62
YUKON	2009	5.3	8	MPFI	SENSOR DE PRESIÓN, 3 TERMINALES	PS516	65
	07-08					PS264	62
	09-14	6.2				PS516	65
	14-20					INDICADOR DE LUZ, 3 TERMINALES	

BULBO DE PRESIÓN DE ACEITE**HONDA**

MODELO	AÑO	LTS.	CIL.	MODO DE INYECCIÓN	CARACTERÍSTICAS	NO. DE PARTE	
ACCORD	03-07	2.4	4	MPFI	INDICADOR DE LUZ, 1 TERMINAL	PS514	64
	08-17					PS386	
	96-97	2.2				PS514	
	98-02	2.3					
	98-07	3.0	6				
CITY	14-20	1.5	4	MPFI	INDICADOR DE LUZ, 1 TERMINAL	PS386	64
CIVIC	03-05	1.7	4	MPFI	INDICADOR DE LUZ, 1 TERMINAL	PS514	64
	06-14	1.8				PS386	
	16-20	2.0					
CIVIC COUPE	12-14	2.4	4	MPFI	INDICADOR DE LUZ, 1 TERMINAL	PS386	64
CIVIC DOHC	99-00	1.6	4	MPFI	INDICADOR DE LUZ, 1 TERMINAL	PS514	64
CIVIC HÍBRIDO	06-11	1.3	4	MPFI	INDICADOR DE LUZ, 1 TERMINAL	PS386	64
	12-14	1.5					
CIVIC SI	07-09	2.0	4	MPFI	INDICADOR DE LUZ, 1 TERMINAL	PS386	64
CIVIC SOHC	97-00	1.6	4	MPFI	INDICADOR DE LUZ, 1 TERMINAL	PS514	64
CIVIC TURBO	16-20	1.5	4	MPFI	INDICADOR DE LUZ, 1 TERMINAL	PS386	64
CR-V	02-06	2.4	4	MPFI	INDICADOR DE LUZ, 1 TERMINAL	PS514	64
	07-19					PS386	
CR-V TURBO	17-20	1.5	4	MPFI	INDICADOR DE LUZ, 1 TERMINAL	PS386	64
CR-Z HÍBRIDO	13-15	1.5	4	MPFI	INDICADOR DE LUZ, 1 TERMINAL	PS386	64
FIT	09-14	1.5	4	MPFI	INDICADOR DE LUZ, 1 TERMINAL	PS386	64
HR-V	16-20	1.8	4	MPFI	INDICADOR DE LUZ, 1 TERMINAL	PS386	64
ODYSSEY	2019	3.5	6	MPFI	INDICADOR DE LUZ, 1 TERMINAL	PS514	64
	00-07						
PILOT	03-08	3.5	6	MPFI	INDICADOR DE LUZ, 1 TERMINAL	PS514	64
RIDGELINE	07-08	3.5	6	MPFI	INDICADOR DE LUZ, 1 TERMINAL	PS514	64

HUMMER

MODELO	AÑO	LTS.	CIL.	MODO DE INYECCIÓN	CARACTERÍSTICAS	NO. DE PARTE	
H2	2008	6.2	8	MPFI	SENSOR DE PRESIÓN, 3 TERMINALES	PS264	62
	2009					PS516	65
	05-07	6.0				PS264	62
H3	2006	3.5	5	MPFI	INDICADOR DE LUZ, 2 TERMINALES	PS269	62
	2008	5.3	8		SENSOR DE PRESIÓN, 3 TERMINALES	PS264	
	09-10					PS516	
H3T	09-10	3.7	5	MPFI	INDICADOR DE LUZ, 2 TERMINALES	PS269	62
		5.3	8		SENSOR DE PRESIÓN, 3 TERMINALES	PS516	65

BULBO DE PRESIÓN DE ACEITE

HYUNDAI

MODELO	AÑO	LTS.	CIL.	MODO DE INYECCIÓN	CARACTERÍSTICAS	NO. DE PARTE	
ACCENT	18-19	1.6	4	MPFI	INDICADOR DE LUZ, 1 TERMINAL	PS361	63
ELANTRA	15-16	1.8	4	MPFI	INDICADOR DE LUZ, 1 TERMINAL	PS361	63
	17-18	2.0					
SONATA	15-17	2.4	4	MPFI	INDICADOR DE LUZ, 1 TERMINAL	PS361	63
SONATA TURBO	16-17	2.0	4	MPFI	INDICADOR DE LUZ, 1 TERMINAL	PS361	63
TUCSON	16-17	2.0	4	MPFI	INDICADOR DE LUZ, 1 TERMINAL	PS361	63

JEEP

MODELO	AÑO	LTS.	CIL.	MODO DE INYECCIÓN	CARACTERÍSTICAS	NO. DE PARTE	
CHEROKEE	1994	4.0	6	MPFI	INDICADOR DE LUZ, 1 TERMINAL	PS216	61
	1998				INDICADOR DE AGUJA, 2 TERMINALES	PS217	
	99-01				SENSOR DE PRESIÓN, 3 TERMINALES	PS257	62
COMMANDER	06-07	4.7	8	MPFI	INDICADOR DE LUZ, 1 TERMINAL	PS274	62
	06-10	5.7			SENSOR DE PRESIÓN, 3 TERMINALES	PS350	63
COMPASS	07-17	2.4	4	MPFI	INDICADOR DE LUZ, 1 TERMINAL	PS511	64
GRAND CHEROKEE	1998	4.0	6	MPFI	INDICADOR DE AGUJA, 2 TERMINALES	PS257	62
		5.2	8				
		5.9	8				
	2005	3.7	6		SENSOR DE PRESIÓN, 3 TERMINALES	PS350	63
		4.7	8				
		5.7	8				
	03-04	4.0	6		INDICADOR DE LUZ, 1 TERMINAL	PS274	62
	03-09	4.7	8				
	05-10	3.7	6				
	05-16	5.7	8		SENSOR DE PRESIÓN, 3 TERMINALES	PS350	63
	11-16	3.6	6				
	93-96	5.2	8				
	94-95	4.0	6		INDICADOR DE LUZ, 1 TERMINAL	PS216	61
		5.2	8			PS217	
	94-96	4.0	6		PS216		
96-97	4.0	6	INDICADOR DE AGUJA, 2 TERMINALES	PS66	63		
	5.2	8					
99-02	4.0	6	SENSOR DE PRESIÓN, 3 TERMINALES	PS350			
	4.7	8					
GRAND CHEROKEE SRT-8	06-10	6.1	8	MPFI	SENSOR DE PRESIÓN, 3 TERMINALES	PS350	63
	13-16	6.4					
LIBERTY	2002	3.7	6	MPFI	SENSOR DE PRESIÓN, 3 TERMINALES	PS350	63
	03-10				INDICADOR DE LUZ, 1 TERMINAL	PS274	62
PATRIOT	07-17	2.4	4	MPFI	INDICADOR DE LUZ, 1 TERMINAL	PS511	64

BULBO DE PRESIÓN DE ACEITE**JEEP**

MODELO	AÑO	LTS.	CIL.	MODO DE INYECCIÓN	CARACTERÍSTICAS	NO. DE PARTE		
WRANGLER	1997	2.5	4	MPFI	INDICADOR DE AGUJA, 2 TERMINALES	PS66	58	
	1998	4.0	6			INDICADOR DE LUZ, 1 TERMINAL	PS257	62
	03-06	2.4	4		PS254		PS274	
		4.0	6					
	07-10	3.8	6		PS216		61	
	93-95	2.5	4		PS217			
	99-02	4.0	6		SENSOR DE PRESIÓN, 3 TERMINALES		PS350	63

KIA

MODELO	AÑO	LTS.	CIL.	MODO DE INYECCIÓN	CARACTERÍSTICAS	NO. DE PARTE	
FORTE	16-19	2.0	4	MPFI	INDICADOR DE LUZ, 1 TERMINAL	PS361	63
FORTE TURBO	2019	1.6	4	MPFI	INDICADOR DE LUZ, 1 TERMINAL	PS361	63
OPTIMA	16-19	2.4	4	MPFI	INDICADOR DE LUZ, 1 TERMINAL	PS361	63
OPTIMA TURBO	16-19	2.0	4	MPFI	INDICADOR DE LUZ, 1 TERMINAL	PS361	63
RIO	16-19	1.6	4	MPFI	INDICADOR DE LUZ, 1 TERMINAL	PS361	63
SORENTO	16-19	2.4	4	MPFI	INDICADOR DE LUZ, 1 TERMINAL	PS361	63
		3.3	6				
SOUL	16-19	1.6	4	MPFI	INDICADOR DE LUZ, 1 TERMINAL	PS361	63
		2.0					
SPORTAGE	16-21	2.0	4	MPFI	INDICADOR DE LUZ, 1 TERMINAL	PS361	63
		2.4					

LINCOLN

MODELO	AÑO	LTS.	CIL.	MODO DE INYECCIÓN	CARACTERÍSTICAS	NO. DE PARTE	
NAVIGATOR	07-14	5.4	8	MPFI	INDICADOR DE AGUJA, 1 TERMINAL	PS503	64
	98-06				INDICADOR DE LUZ, 1 TERMINAL	PS241	62
TOWN CAR	00-05	4.6	8	MPFI	INDICADOR DE LUZ, 1 TERMINAL	PS241	62
	06-07					PS503	64

BULBO DE PRESIÓN DE ACEITE

MAZDA

MODELO	AÑO	LTS.	CIL.	MODO DE INYECCIÓN	CARACTERÍSTICAS	NO. DE PARTE	
2	12-15	1.5	4	MPFI	INDICADOR DE LUZ, 1 TERMINAL	PS85	59
3	06-09	2.3	4	MPFI	INDICADOR DE LUZ, 1 TERMINAL	PS504	64
	06-13	2.0					
	10-13	2.5					
	12-18	2.0					
	14-18	2.5			INDICADOR DE LUZ Y MEDIDOR, 1 TERMINAL	PS520	65
3 SPEED TURBO	08-13	2.3	4	MPFI	INDICADOR DE LUZ, 1 TERMINAL	PS504	64
5	06-10	2.3	4	MPFI	INDICADOR DE LUZ, 1 TERMINAL	PS504	64
	12-15	2.5					
6	06-08	2.3	4	MPFI	INDICADOR DE LUZ, 1 TERMINAL	PS504	64
		3.0	6			PS317	63
	09-10	2.5	4			PS313	
	09-13	3.7	6			PS241	62
	12-13	2.5	4			PS313	63
	14-17					PS520	65
CX-3	16-18	2.0	4	MPFI	INDICADOR DE LUZ, 1 TERMINAL	PS520	65
CX-5	13-17	2.0	4	MPFI	INDICADOR DE LUZ, 1 TERMINAL	PS520	65
	14-17	2.5					
CX-7	10-12	2.5	4	MPFI	INDICADOR DE LUZ, 1 TERMINAL	PS504	64
CX-7 TURBO	10-12	2.3	4	MPFI	INDICADOR DE LUZ, 1 TERMINAL	PS504	64
CX-9	2007	3.5	6	MPFI	INDICADOR DE LUZ, 1 TERMINAL	PS241	62
	11-12	3.7					
MX-5	06-15	2.0	4	MPFI	INDICADOR DE LUZ, 1 TERMINAL	PS504	64

MERCURY

MODELO	AÑO	LTS.	CIL.	MODO DE INYECCIÓN	CARACTERÍSTICAS	NO. DE PARTE	
MARINER	08-11	3.0	6	MPFI	INDICADOR DE LUZ, 1 TERMINAL	PS500	64
MILAN	07-08	3.0	6	MPFI	INDICADOR DE LUZ, 1 TERMINAL	PS500	64
MONTEGO	05-07	3.0	6	MPFI	INDICADOR DE LUZ, 1 TERMINAL	PS317	63
MYSTIQUE	1995	2.0	4	MPFI	INDICADOR DE LUZ, 1 TERMINAL	PS230	61
	95-98	2.5	6			PS317	63
	98-00						
SABLE	1995	3.8	6	MPFI	INDICADOR DE LUZ, 1 TERMINAL	PS68	58
	96-98	3.0				PS305	62
	99-04					PS317	63

BULBO DE PRESIÓN DE ACEITE**MINI**

MODELO	AÑO	LTS.	CIL.	MODO DE INYECCIÓN	CARACTERÍSTICAS	NO. DE PARTE	
COOPER	07-10	1.6	4	MPFI	INDICADOR DE AGUJA, 1 TERMINAL	PS508	64
	07-12						
COOPER TURBO	07-12	1.6	4	MPFI	INDICADOR DE AGUJA, 1 TERMINAL	PS508	64

MITSUBISHI

MODELO	AÑO	LTS.	CIL.	MODO DE INYECCIÓN	CARACTERÍSTICAS	NO. DE PARTE	
ECLIPSE	04-05	3.0	6	MPFI	INDICADOR DE LUZ, 1 TERMINAL	PS290	62
GALANT	2003	3.0	6	MPFI	INDICADOR DE LUZ, 1 TERMINAL	PS290	62
	2004	3.8					
LANCER	2006	2.0	4	MPFI	INDICADOR DE LUZ, 1 TERMINAL	PS290	62
MIRAGE	15-19	1.2	3	MPFI	1 TERMINAL	PS517	65
MIRAGE G4	2019	1.2	3	MPFI	1 TERMINAL	PS517	65
	21-23						

NISSAN

MODELO	AÑO	LTS.	CIL.	MODO DE INYECCIÓN	CARACTERÍSTICAS	NO. DE PARTE	
24SX	1993	2.4	4	MPFI	INDICADOR DE LUZ, 1 TERMINAL	PS131	59
	1998						
350Z	03-08	3.5	6	MPFI	SENSOR DE PRESIÓN, 3 TERMINALES	PS133	59
370Z	09-15	3.7	6	MPFI	INDICADOR DE LUZ, 1 TERMINAL	PS337	63
620 PICK UP	1979	2.0	4	CARBURADO	INDICADOR DE LUZ Y AGUJA, 2 TERMINALES	PS132	59
720 PICK UP	80-85	2.0	4	CARBURADO	INDICADOR DE LUZ Y AGUJA, 2 TERMINALES	PS132	59
ALTIMA	02-06	3.5	6	MPFI	INDICADOR DE LUZ, 1 TERMINAL	PS131	59
	02-13	2.5	4			PS337	63
	05-06				3.5	6	SENSOR DE PRESIÓN, 3 TERMINALES
	07-13	INDICADOR DE LUZ, 1 TERMINAL	PS337				63
	96-01	4	INDICADOR DE LUZ, 1 TERMINAL				PS131
ARMADA	05-06	5.6	8	MPFI	SENSOR DE PRESIÓN, 3 TERMINALES	PS133	59
	07-15				INDICADOR DE LUZ, 1 TERMINAL	PS337	63
D21	91-97	2.4	4	MPFI	INDICADOR DE LUZ, 1 TERMINAL	PS131	59
FRONTIER	2001	2.4	4	MPFI	INDICADOR DE LUZ, 1 TERMINAL	PS131	59
		3.3	6				
	02-04	2.4	4			PS337	63
		3.3	6				

BULBO DE PRESIÓN DE ACEITE

NISSAN

MODELO	AÑO	LTS.	CIL.	MODO DE INYECCIÓN	CARACTERÍSTICAS	NO. DE PARTE	
FRONTIER	06-08	2.4	4	MPFI	SENSOR DE PRESIÓN, 3 TERMINALES	PS133	59
	07-08				INDICADOR DE LUZ, 1 TERMINAL	PS337	63
	08-09	4.0	6		SENSOR DE PRESIÓN, 3 TERMINALES	PS133	59
	11-15				2.4	4	INDICADOR DE LUZ, 1 TERMINAL
MAXIMA	04-08	3.5	6	MPFI	INDICADOR DE LUZ, 1 TERMINAL INDICADOR DE LUZ, 1 TERMINAL	PS131	59
	09-14					PS337	63
	91-93	3.0				PS131	59
	95-01					PS131	59
MURANO	04-07	3.5	6	MPFI	INDICADOR DE LUZ, 1 TERMINAL	PS131	59
	09-14					PS337	63
NP300	09-15	2.4	4	MPFI	INDICADOR DE LUZ, 1 TERMINAL	PS337	63
	16-20	2.5			3 TERMINALES	PS519	65
PATHFINDER	2001	3.5	6	MPFI	INDICADOR DE LUZ, 1 TERMINAL	PS131	59
	02-04					PS337	63
	05-06	4.0			SENSOR DE PRESIÓN, 3 TERMINALES	PS133	59
	07-12				INDICADOR DE LUZ, 1 TERMINAL	PS337	63
	97-00				3.3	PS131	59
PATHFINDER ARMADA	2004	5.6	8	MPFI	SENSOR DE PRESIÓN, 3 TERMINALES	PS133	59
PLATINA	02-10	1.6	4	MPFI	INDICADOR DE LUZ, 1 TERMINAL	PS136	59
QUEST	04-09	3.5	6	MPFI	INDICADOR DE LUZ, 1 TERMINAL	PS131	59
	97-98	3.0					
	99-02	3.3					
ROGUE	08-13	2.5	4	MPFI	INDICADOR DE LUZ, 1 TERMINAL	PS337	63
SENTRA	1992	1.6	4	MPFI	INDICADOR DE LUZ, 1 TERMINAL	PS131	59
	2001	1.8				PS337	63
	02-06					PS131	59
	07-12	2.0				PS337	63
	96-00	1.6				PS131	59
	96-01	2.0					
SENTRA SE-R	02-06	2.5	4	MPFI	INDICADOR DE LUZ, 1 TERMINAL	PS337	63
	07-12				SENSOR DE PRESIÓN, 3 TERMINALES	PS133	59
TIIDA	07-18	1.8	4	MPFI	INDICADOR DE LUZ, 1 TERMINAL	PS337	63
TITAN	04-07	5.6	8	MPFI	SENSOR DE PRESIÓN, 3 TERMINALES	PS133	59
	08-15				INDICADOR DE LUZ, 1 TERMINAL	PS337	63
TSURU II	91-92	1.6	4	CARBURADO	INDICADOR DE LUZ, 1 TERMINAL	PS131	59
TSURU III	01-17	1.6	4	MPFI	INDICADOR DE LUZ, 1 TERMINAL	PS337	63
	93-00					PS131	59
TSURU III GSR 2000	1994	2.0	4	MPFI	INDICADOR DE LUZ, 1 TERMINAL	PS131	59
V-DRIVE	20-22	1.6	4	MPFI	INDICADOR DE LUZ, 1 TERMINAL	PS337	63

BULBO DE PRESIÓN DE ACEITE**NISSAN**

MODELO	AÑO	LTS.	CIL.	MODO DE INYECCIÓN	CARACTERÍSTICAS	NO. DE PARTE	
VERSA	12-19	1.6	4	MPFI	INDICADOR DE LUZ, 1 TERMINAL	PS337	63
X-TRAIL	02-07	2.5	4	MPFI	INDICADOR DE LUZ, 1 TERMINAL	PS337	63
	11-12						
XTERRA	00-01	2.4	4	MPFI	INDICADOR DE LUZ, 1 TERMINAL	PS131	59
		3.3	6				
	02-04	2.4	4			PS337	63
		3.3	6				
	05-07	4.0	6		SENSOR DE PRESIÓN, 3 TERMINALES	PS133	59
					INDICADOR DE LUZ, 1 TERMINAL	PS337	63

OLDSMOBILE

MODELO	AÑO	LTS.	CIL.	MODO DE INYECCIÓN	CARACTERÍSTICAS	NO. DE PARTE	
CUTLASS	89-91	3.1	6	MPFI	INDICADOR DE LUZ Y AGUJA, 3 TERMINALES	PS165	60
	91-92					PS162	
SILHOUETTE	91-92	3.1	6	TBI	INDICADOR DE LUZ Y AGUJA, 3 TERMINALES	PS162	60

PEUGEOT

MODELO	AÑO	LTS.	CIL.	MODO DE INYECCIÓN	CARACTERÍSTICAS	NO. DE PARTE	
206	00-09	1.4	4	MPFI	INDICADOR DE AGUJA, 1 TERMINAL	PS508	64
	01-09	1.6					
207	09-11	1.4	4	MPFI	INDICADOR DE AGUJA, 1 TERMINAL	PS508	64
	10-13	1.6					
207 TURBO	08-14	1.6	4	MPFI	INDICADOR DE AGUJA, 1 TERMINAL	PS508	64

PONTIAC

MODELO	AÑO	LTS.	CIL.	MODO DE INYECCIÓN	CARACTERÍSTICAS	NO. DE PARTE	
AZTEK	01-05	3.4	6	MPFI	INDICADOR DE LUZ, 1 TERMINAL	PS211	61
FIREBIRD TRANS AM	1999	5.7	8	MPFI	MEDIDOR, 1 TERMINAL	PS237	63
	94-97				INDICADOR DE LUZ Y AGUJA, 3 TERMINALES	PS165	60
G3 MOTOR IMP.	2009	1.6	4	MPFI	INDICADOR DE LUZ, 1 TERMINAL	PS213	61
G5	07-09	2.2	4	MPFI	INDICADOR DE LUZ, 1 TERMINAL	PS505	64
G5 GT	07-08	2.4	4	MPFI	INDICADOR DE LUZ, 1 TERMINAL	PS505	64
G6	07-09	3.6	6	MPFI	INDICADOR DE LUZ, 2 TERMINALES	PS269	62

BULBO DE PRESIÓN DE ACEITE

PONTIAC

MODELO	AÑO	LTS.	CIL.	MODO DE INYECCIÓN	CARACTERÍSTICAS	NO. DE PARTE	
G6 GT	2005	3.5	6	MPFI	INDICADOR DE LUZ, 1 TERMINAL	PS211	61
GRAND AM	03-04	3.4	6	MPFI	INDICADOR DE LUZ, 1 TERMINAL	PS211	61
GRAND PRIX	97-01	3.1	6	MPFI	INDICADOR DE LUZ, 1 TERMINAL	PS211	61
MATIZ	04-10	1.0	4	MPFI	INDICADOR DE LUZ, 1 TERMINAL	PS526	65
MONTANA	05-06	3.5	6	MPFI	INDICADOR DE LUZ, 1 TERMINAL	PS211	61
SOLSTICE	06-09	2.4	4	MPFI	INDICADOR DE LUZ, 1 TERMINAL	PS505	64
SOLSTICE GXP	2009	2.0	4	MPFI	INDICADOR DE LUZ, 1 TERMINAL	PS505	64
SUNFIRE	97-02	2.2	4	MPFI	INDICADOR DE LUZ, 1 TERMINAL	PS211	61
		2.4					
TORRENT	06-09	3.4	6	MPFI	INDICADOR DE LUZ, 1 TERMINAL	PS211	61

PORSCHE

MODELO	AÑO	LTS.	CIL.	MODO DE INYECCIÓN	CARACTERÍSTICAS	NO. DE PARTE	
CAYENNE	03-06	4.5	8	MPFI	INDICADOR DE LUZ Y MEDIDOR, 1 TERMINAL	PS518	65
	05-06	3.2	6		INDICADOR DE LUZ, 1 TERMINAL		
CAYENNE TURBO	03-06	4.5	8	MPFI	INDICADOR DE LUZ Y MEDIDOR, 1 TERMINAL	PS518	65

RAM

MODELO	AÑO	LTS.	CIL.	MODO DE INYECCIÓN	CARACTERÍSTICAS	NO. DE PARTE	
1500	14-16	3.6	6	MPFI	SENSOR DE PRESIÓN, 3 TERMINALES	PS350	63
2500	11-13	4.7	8	MPFI	SENSOR DE PRESIÓN, 3 TERMINALES	PS350	63
	11-16	5.7					
RAM 700	15-20	1.6	4	MPFI	INDICADOR DE LUZ, 1 TERMINAL	PS522	65

RENAULT

MODELO	AÑO	LTS.	CIL.	MODO DE INYECCIÓN	CARACTERÍSTICAS	NO. DE PARTE	
CLIO	02-10	1.6	4	MPFI	INDICADOR DE LUZ, 1 TERMINAL	PS136	59

BULBO DE PRESIÓN DE ACEITE**SEAT**

MODELO	AÑO	LTS.	CIL.	MODO DE INYECCIÓN	CARACTERÍSTICAS	NO. DE PARTE	
IBIZA	01-02	1.6	4	MPFI	INDICADOR DE LUZ, 1 TERMINAL	PS365	63
	03-04	2.0				PS387	64
	10-21	1.6					
LEON TURBO	01-05	1.8	4	MPFI	INDICADOR DE LUZ, 1 TERMINAL	PS365	63

SUBARU

MODELO	AÑO	LTS.	CIL.	MODO DE INYECCIÓN	CARACTERÍSTICAS	NO. DE PARTE	
FORESTER	09-12	2.5	4	MPFI	INDICADOR DE LUZ, 1 TERMINAL	PS85	59
FORESTER XT	11-12	2.5	4	MPFI	INDICADOR DE LUZ, 1 TERMINAL	PS85	59
IMPREZA	08-11	2.0	4	MPFI	INDICADOR DE LUZ, 1 TERMINAL	PS85	59
	13-14						

SUZUKI

MODELO	AÑO	LTS.	CIL.	MODO DE INYECCIÓN	CARACTERÍSTICAS	NO. DE PARTE	
AERIO	06-07	2.3	4	MPFI	INDICADOR DE LUZ, 1 TERMINAL	PS85	59
XL-7	07-09	3.6	6	MPFI	INDICADOR DE LUZ, 2 TERMINALES	PS269	62

TOYOTA

MODELO	AÑO	LTS.	CIL.	MODO DE INYECCIÓN	CARACTERÍSTICAS	NO. DE PARTE	
4RUNNER	03-09	4.7	8	MPFI	INDICADOR DE LUZ, 1 TERMINAL	PS223	61
	06-09	4.0	6				
CAMRY	02-06	3.0	6	MPFI	INDICADOR DE LUZ, 1 TERMINAL	PS223	61
	02-09	2.4	4				
	12-15	2.5	4				
		3.5	6				
COROLLA	03-15	1.8	4	MPFI	INDICADOR DE LUZ, 1 TERMINAL	PS223	61
COROLLA XRS	09-13	2.4	4	MPFI	INDICADOR DE LUZ, 1 TERMINAL	PS223	61
FJ CRUISER	08-14	4.0	6	MPFI	INDICADOR DE LUZ, 1 TERMINAL	PS223	61
HIACE	06-19	2.7	4	MPFI	INDICADOR DE LUZ, 1 TERMINAL	PS223	61
HIGHLANDER	08-11	3.5	6	MPFI	INDICADOR DE LUZ, 1 TERMINAL	PS223	61
MATRIX	03-10	1.8	4	MPFI	INDICADOR DE LUZ, 1 TERMINAL	PS223	61
	09-10	2.4					
PRIUS HÍBRIDO	10-14	1.8	4	MPFI	INDICADOR DE LUZ, 1 TERMINAL	PS223	61

BULBO DE PRESIÓN DE ACEITE

TOYOTA

MODELO	AÑO	LTS.	CIL.	MODO DE INYECCIÓN	CARACTERÍSTICAS	NO. DE PARTE	
RAV4	04-08	2.4	4	MPFI	INDICADOR DE LUZ, 1 TERMINAL	PS223	61
	09-12	3.5	6				
	10-15	2.5	4				
SIENNA	04-06	3.3	6	MPFI	INDICADOR DE LUZ, 1 TERMINAL	PS223	61
	07-20	3.5					
SOLARA	04-08	3.3	6	MPFI	INDICADOR DE LUZ, 1 TERMINAL	PS223	61
TACOMA	2016	3.5	6	MPFI	INDICADOR DE LUZ, 1 TERMINAL	PS223	61
	06-15	4.0					
TUNDRA	2007	4.0	6	MPFI	INDICADOR DE LUZ, 1 TERMINAL	PS223	61
YARIS	06-21	1.5	4	MPFI	INDICADOR DE LUZ, 1 TERMINAL	PS223	61

VAM

MODELO	AÑO	LTS.	CIL.	MODO DE INYECCIÓN	CARACTERÍSTICAS	NO. DE PARTE	
RAMBLER	74-76	4.3	6	CARBURADO	INDICADOR DE LUZ Y AGUJA, 3 TERMINALES	PS87	59

VOLKSWAGEN

MODELO	AÑO	LTS.	CIL.	MODO DE INYECCIÓN	CARACTERÍSTICAS	NO. DE PARTE	
BEETLE	2014	2.5	5	MPFI	INDICADOR DE LUZ, 1 TERMINAL	PS515	64
	00-01	2.0	4		1 TERMINAL	PS507	
	06-10	2.5	5		INDICADOR DE LUZ, 2 TERMINALES	PS363	63
	07-10	2.0	4		INDICADOR DE LUZ, 1 TERMINAL	PS365	
	12-13	2.5	5				
	98-05	2.0	4				
BEETLE TDI	03-06	1.9	4	MPFI			INDICADOR DE LUZ, 1 TERMINAL
BEETLE TURBO	00-01	1.8	4	MPFI	1 TERMINAL	PS507	64
	04-05				INDICADOR DE LUZ, 1 TERMINAL	PS365	63
	12-13	2.0					
	99-02	1.8					
BORA	07-09	2.5	5	MPFI	INDICADOR DE LUZ, 2 TERMINALES	PS363	63
BORA GLI	2006	2.0	4	MPFI	INDICADOR DE LUZ, 2 TERMINALES	PS363	63
					INDICADOR DE LUZ, 1 TERMINAL	PS365	
BORA TDI	08-09	1.9	4	MPFI	INDICADOR DE LUZ, 1 TERMINAL	PS518	65
BRASILIA	78-82	1.6	4	CARBURADO	INDICADOR DE LUZ, 1 TERMINAL	PS125	59
CARIBE	81-87	1.7	4	MPFI	INDICADOR DE LUZ, 1 TERMINAL	PS122	59
COMBI	78-88	1.6	4	CARBURADO	INDICADOR DE LUZ, 1 TERMINAL	PS125	59

BULBO DE PRESIÓN DE ACEITE

VOLKSWAGEN

MODELO	AÑO	LTS.	CIL.	MODO DE INYECCIÓN	CARACTERÍSTICAS	NO. DE PARTE	
CRAFTER TDI	2008	2.5	5	MPFI	INDICADOR DE LUZ, 1 TERMINAL	PS518	65
CROSSFOX	07-09	1.6	4	MPFI	1 TERMINAL	PS507	64
DERBY	2003	2.0	4	MPFI	INDICADOR DE LUZ, 1 TERMINAL	PS122	59
	95-09	1.8				PS137	
						PS122	
95-09	1.8	PS137					
		PS137					
EOS TURBO	2010	2.0	4	MPFI	INDICADOR DE LUZ, 2 TERMINALES	PS363	63
EUROVAN	01-02	2.5	5	MPFI	INDICADOR DE LUZ, 1 TERMINAL	PS137	59
						PS365	63
EUROVAN VR6	00-02	2.8	6	MPFI	INDICADOR DE LUZ, 1 TERMINAL	PS137	59
						PS365	63
GOL	09-20	1.6	4	MPFI	INDICADOR DE LUZ, 1 TERMINAL	PS387	64
GOLF	87-88	1.8	4	MPFI	INDICADOR DE LUZ, 1 TERMINAL	PS122	59
GOLF A2	87-92	1.8	4	MPFI	INDICADOR DE LUZ, 1 TERMINAL	PS137	59
	89-92					PS122	
GOLF A3	1999	1.8	4	MPFI	INDICADOR DE LUZ, 1 TERMINAL	PS365	63
		2.0					
	92-99	1.8				PS122	59
	93-99	2.0				PS137	
						PS122	
1999	1.8	PARA MEDIDOR, 1 TERMINAL	PS518	65			
GOLF A3 VR6	1999	2.8	6	MPFI	INDICADOR DE LUZ, 1 TERMINAL	PS122	59
						PS365	63
	96-99	PS137	59				
GOLF A4	00-06	2.0	4	MPFI	INDICADOR DE LUZ, 1 TERMINAL	PS365	63
	04-06				PARA MEDIDOR, 1 TERMINAL	PS518	65
GOLF A4 GTI	00-05	1.8	4	MPFI	INDICADOR DE LUZ, 1 TERMINAL	PS365	63
	04-06				PARA MEDIDOR, 1 TERMINAL	PS518	65
GOLF A4 R32	2004	3.2	6	MPFI	INDICADOR DE LUZ, 1 TERMINAL	PS365	63
GOLF A4 TURBO	00-02	1.8	4	MPFI	PARA MEDIDOR, 1 TERMINAL	PS518	65
GOLF A5 GTI	07-08	2.0	4	MPFI	INDICADOR DE LUZ, 2 TERMINALES	PS363	63
GOLF A5 SPORT WAGEN	10-13	2.5	5	MPFI	INDICADOR DE LUZ, 2 TERMINALES	PS363	63
					PARA MEDIDOR, 1 TERMINAL	PS518	65
GOLF A6 GTI	08-13	2.0	4	MPFI	INDICADOR DE LUZ, 1 TERMINAL	PS365	63
GOLF A6 TURBO	2013	1.4	4	MPFI	PARA MEDIDOR, 1 TERMINAL	PS518	65
GOLF A7 TURBO	2019	1.4	4	MPFI	INDICADOR DE LUZ, 1 TERMINAL	PS515	64
	16-18				PARA MEDIDOR, 1 TERMINAL	PS518	65

BULBO DE PRESIÓN DE ACEITE

VOLKSWAGEN

MODELO	AÑO	LTS.	CIL.	MODO DE INYECCIÓN	CARACTERÍSTICAS	NO. DE PARTE		
JETTA A2 TURBO	89-92	1.8	4	MPFI	INDICADOR DE LUZ, 1 TERMINAL	PS122	59	
JETTA A3	90-99	2.0	4	MPFI	INDICADOR DE LUZ, 1 TERMINAL	PS122	59	
	93-99	1.8				PS137		
	93-99	2.0						
JETTA A3 VR6	95-99	2.8	6	MPFI	INDICADOR DE LUZ, 1 TERMINAL	PS122	59	
JETTA A4	00-10	2.0	4	MPFI	INDICADOR DE LUZ, 1 TERMINAL	PS365	63	
	06-07				INDICADOR DE LUZ, 2 TERMINALES	PS363		
	99-01				INDICADOR DE LUZ, 1 TERMINAL	PS122		
	99-04				1 TERMINAL	PS137		
	00-01				INDICADOR DE LUZ, 1 TERMINAL	PS507		
	2.8	6		INDICADOR DE LUZ, 1 TERMINAL	PS518	65		
JETTA A4 CLASICO	10-15	2.0	4	MPFI	INDICADOR DE LUZ, 1 TERMINAL	PS365	63	
JETTA A4 TDI	2010	1.9	4	MPFI	INDICADOR DE LUZ, 1 TERMINAL	PS365	63	
JETTA A4 TURBO	2010	1.8	4	MPFI	INDICADOR DE LUZ, 1 TERMINAL	PS365	63	
	99-00					PS137		
	99-01					PS122		
	99-05					1 TERMINAL		PS507
	00-01					INDICADOR DE LUZ, 1 TERMINAL		PS365
					PS518	65		
JETTA A4 VR6	99-01	2.8	6	MPFI	INDICADOR DE LUZ, 1 TERMINAL	PS122	59	
	99-04				1 TERMINAL	PS365	63	
					PS507	64		
JETTA A6	11-14	2.5	5	MPFI	INDICADOR DE LUZ, 2 TERMINALES	PS363	63	
	11-16				INDICADOR DE LUZ, 1 TERMINAL	PS518	65	
	16-18	2.0	4					
JETTA A6 GLI	2013	2.0	4	MPFI	INDICADOR DE LUZ, 1 TERMINAL	PS518	65	
	15-17							
JETTA A7 TURBO	19-21	1.4	4	MPFI	INDICADOR DE LUZ, 1 TERMINAL	PS515	64	
LUPO	05-09	1.6	4	MPFI	1 TERMINAL	PS507	64	
PASSAT	03-04	4.0	8	MPFI	INDICADOR DE LUZ, 1 TERMINAL	PS365	63	
	91-93	2.0	4			PS122	59	
					PS137			
PASSAT TURBO	06-08	2.0	4	MPFI	INDICADOR DE LUZ, 2 TERMINALES	PS363	63	
	08-10				INDICADOR DE LUZ, 1 TERMINAL	PS365		
	99-05				1.8			
PASSAT VR6	96-97	2.8	6	MPFI	INDICADOR DE LUZ, 1 TERMINAL	PS137	59	
	97-05					PS365	63	
POINTER	99-09	1.8	4	MPFI	INDICADOR DE LUZ, 1 TERMINAL	PS385	63	
POINTER GTI	00-03	2.0	4	MPFI	INDICADOR DE LUZ, 1 TERMINAL	PS385	63	

BULBO DE PRESIÓN DE ACEITE**VOLKSWAGEN**

MODELO	AÑO	LTS.	CIL.	MODO DE INYECCIÓN	CARACTERÍSTICAS	NO. DE PARTE	
POLO	03-07	1.6	4	MPFI	1 TERMINAL	PS507	64
	15-20				INDICADOR DE LUZ, 1 TERMINAL	PS387	
ROUTAN	2011	3.6	6	MPFI	SENSOR DE PRESIÓN, 3 TERMINALES	PS350	63
	09-10	3.8			INDICADOR DE LUZ, 1 TERMINAL	PS254	62
SAFARI	78-80	1.6	4	CARBURADO	INDICADOR DE LUZ, 1 TERMINAL	PS125	59
SEDAN	64-67	1.2	4	CARBURADO	INDICADOR DE LUZ, 1 TERMINAL	PS125	59
	68-73	1.5					
	74-92	1.6		MPFI			
	93-04						
SHARAN TURBO	02-08	1.8	4	MPFI	INDICADOR DE LUZ, 1 TERMINAL	PS365	63
TOUAREG	04-07	3.2	6	MPFI	INDICADOR DE LUZ, 1 TERMINAL	PS365	63
	04-09	4.2	8				
TOUAREG TDI	2007	4.9	10	MPFI	INDICADOR DE LUZ, 1 TERMINAL	PS365	63
VAN	05-09	1.8	4	MPFI	INDICADOR DE LUZ, 1 TERMINAL	PS385	63
VENTO	14-20	1.6	4	MPFI	INDICADOR DE LUZ, 1 TERMINAL	PS387	64
VIRTUS	20-21	1.6	4	MPFI	INDICADOR DE LUZ, 1 TERMINAL	PS387	64

BULBO DE PRESIÓN DE ACEITE



PS14



PS59



PS66



PS68



PS72



PS75



PS76



PS77



PS79



PS88



PS90



PS91

BULBO DE PRESIÓN DE ACEITE



PS95



PS103



PS104



PS122



PS125



PS131



PS132



PS133



PS136



PS137



PS139



PS143

BULBO DE PRESIÓN DE ACEITE



PS153



PS154



PS161



PS162



PS165



PS167



PS168



PS170



PS171



PS176



PS177



PS181

BULBO DE PRESIÓN DE ACEITE



PS185



PS193



PS201



PS211



PS212



PS213



PS214



PS216



PS217



PS223



PS228



PS230

BULBO DE PRESIÓN DE ACEITE



PS237



PS238



PS241



PS254



PS257



PS261



PS264



PS269



PS274



PS290



PS305



PS306

BULBO DE PRESIÓN DE ACEITE



PS313



PS316



PS317



PS337



PS350



PS361



PS363



PS365



PS378



PS382



PS384



PS385

BULBO DE PRESIÓN DE ACEITE



PS386



PS387



PS500



PS503



PS504



PS505



PS507



PS508



PS511



PS512



PS514



PS515

BULBO DE PRESIÓN DE ACEITE



PS516



PS517

NUEVO



PS518

NUEVO



PS519

NUEVO



PS520

NUEVO



PS521

NUEVO



PS522

NUEVO



PS523

NUEVO



PS525

NUEVO



PS526

NUEVO



BULBO DE PRESIÓN DE ACEITE DE DIRECCIÓN**NISSAN**

MODELO	AÑO	LTS.	CIL.	MODO DE INYECCIÓN	CARACTERÍSTICAS	NO. DE PARTE	
ALTIMA	02-14	2.5	4	MPFI	3 TERMINALES	PS513	67
		3.5	6				
ARMADA	05-11	5.6	8	MPFI	3 TERMINALES	PS513	67
FRONTIER	06-08	2.4	4	MPFI	3 TERMINALES	PS513	67
	08-10	4.0	6				
MAXIMA	03-14	3.5	6	MPFI	3 TERMINALES	PS513	67
MURANO	04-10	3.5	6	MPFI	3 TERMINALES	PS513	67
PATHFINDER	03-04	3.5	6	MPFI	3 TERMINALES	PS513	67
	05-10	4.0					
PATHFINDER ARMADA	2004	5.6	8	MPFI	3 TERMINALES	PS513	67
QUEST	04-08	3.5	6	MPFI	3 TERMINALES	PS513	67
SENTRA	05-06	2.5	4	MPFI	3 TERMINALES	PS513	67
TITAN	04-11	5.6	8	MPFI	3 TERMINALES	PS513	67
XTERRA	05-07	4.0	6	MPFI	3 TERMINALES	PS513	67



PS513

BULBO DE PRESIÓN DE ACEITE DE TRANSMISIÓN AUTOMÁTICA

HONDA

MODELO	AÑO	LTS.	CIL.	MODO DE INYECCIÓN	CARACTERÍSTICAS	NO. DE PARTE	
ACCORD	03-07	3.0	6	MPFI	1 TERMINAL	PS510	69
	08-16	2.4	4		SEGUNDO Y TERCERO	PS502	
	13-16	3.5	6				
CR-V	12-14	2.4	4	MPFI	SEGUNDO Y TERCERO	PS502	69
FIT	09-13	1.5	4	MPFI	1 TERMINAL	PS509	69
ODYSSEY	02-07	3.5	6	MPFI	1 TERMINAL	PS510	69
	11-16				SEGUNDO Y TERCERO	PS502	
PILOT	03-06	3.5	6	MPFI	1 TERMINAL	PS510	69

MAZDA

MODELO	AÑO	LTS.	CIL.	MODO DE INYECCIÓN	CARACTERÍSTICAS	NO. DE PARTE	
3	06-09	2.3	4	MPFI	1 TERMINAL	PS501	69
	06-13	2.0					
	10-13	2.5					
3 SPEED TURBO	08-13	2.3	4	MPFI	1 TERMINAL	PS501	69
5	06-10	2.3	4	MPFI	1 TERMINAL	PS501	69
	12-13	2.5					
6	06-08	2.3	4	MPFI	1 TERMINAL	PS501	69
		3.0	6				
	09-13	2.5	4				
		3.7	6				
CX-7	10-12	2.5	4	MPFI	1 TERMINAL	PS501	69
CX-7 TURBO	10-12	2.3	4	MPFI	1 TERMINAL	PS501	69

BULBO DE PRESIÓN DE ACEITE DE TRANSMISIÓN AUTOMÁTICA



PS501



PS502



PS509



PS510

BULBO DE PRESIÓN DE ACEITE PARA VÁLVULA VVT

HONDA

MODELO	AÑO	LTS.	CIL.	MODO DE INYECCIÓN	CARACTERÍSTICAS	NO. DE PARTE	
ACCORD	08-12	3.5	6	MPFI	2 TERMINALES	PS506	70
	98-07	3.0					
CIVIC	97-00	1.6	4	MPFI	2 TERMINALES	PS506	70
	99-00						
ODYSSEY	00-10	3.5	6	MPFI	2 TERMINALES	PS506	70
PILOT	03-08	3.5	6	MPFI	2 TERMINALES	PS506	70
RIDGELINE	07-14	3.5	6	MPFI	2 TERMINALES	PS506	70



PS506

BULBO DE REVERSA**CADILLAC**

MODELO	AÑO	LTS.	CIL.	MODO DE INYECCIÓN	CARACTERÍSTICAS	NO. DE PARTE	
CTS	2003	3.2	6	MPFI		BRK-201	75

CHEVROLET

MODELO	AÑO	LTS.	CIL.	MODO DE INYECCIÓN	CARACTERÍSTICAS	NO. DE PARTE	
AVEO	08-18	1.6	4	MPFI		BRK-201	75
CAVALIER	00-04	2.2	4	MPFI		BRK-201	75
HHR	06-09	2.4	4	MPFI		BRK-201	75
TORNADO	14-20	1.8	4	MPFI	2 TERMINALES	BRK-209	75

FORD

MODELO	AÑO	LTS.	CIL.	MODO DE INYECCIÓN	CARACTERÍSTICAS	NO. DE PARTE	
ESCAPE	2010	3.0	6	MPFI	2 TERMINALES	BRK-210	75
	2012	2.5	4				
	09-10						

KIA

MODELO	AÑO	LTS.	CIL.	MODO DE INYECCIÓN	CARACTERÍSTICAS	NO. DE PARTE	
FORTE	16-20	2.0	4	MPFI	2 TERMINALES	BRK-212	75
FORTE TURBO	19-20	1.6	4	MPFI	2 TERMINALES	BRK-212	75
SOUL	16-20	1.6	4	MPFI	2 TERMINALES	BRK-212	75
	16-21	2.0					
SOUL TURBO	17-19	1.6	4	MPFI	2 TERMINALES	BRK-212	75

NISSAN

MODELO	AÑO	LTS.	CIL.	MODO DE INYECCIÓN	CARACTERÍSTICAS	NO. DE PARTE	
APRIO	08-10	1.6	4	MPFI	2 TERMINALES	BRK-208	75
FRONTIER	01-04	2.4	4	MPFI		BRK-202	75
		3.3	6				
MARCH	12-20	1.6	4	MPFI	3 TERMINALES	BRK-211	75
MICRA	05-07	1.4	4	MPFI	3 TERMINALES	BRK-211	75
PATHFINDER	2000	3.3	6	MPFI		BRK-202	75
	01-02	3.5					

BULBO DE REVERSA

NISSAN

MODELO	AÑO	LTS.	CIL.	MODO DE INYECCIÓN	CARACTERÍSTICAS	NO. DE PARTE	
PLATINA	02-10	1.6	4	MPFI	2 TERMINALES	BRK-208	75
SENTRA	07-10	2.0	4	MPFI	3 TERMINALES	BRK-211	75
		2.5			2 TERMINALES	BRK-210	
TSURU II	88-91	1.6	4	MPFI		BRK-215	76
XTERRA	00-04	2.4	4	MPFI		BRK-202	75
		3.3	6				

PONTIAC

MODELO	AÑO	LTS.	CIL.	MODO DE INYECCIÓN	CARACTERÍSTICAS	NO. DE PARTE	
G3 MOTOR IMP.	2009	1.6	4	MPFI		BRK-201	75
G5	07-09	2.2	4	MPFI		BRK-201	75
G5 GT	07-08	2.4	4	MPFI		BRK-201	75
GRAND AM	03-04	3.4	6	MPFI		BRK-201	75
SUNFIRE	00-02	2.4	4	MPFI		BRK-201	75
	00-05	2.2					

RENAULT

MODELO	AÑO	LTS.	CIL.	MODO DE INYECCIÓN	CARACTERÍSTICAS	NO. DE PARTE	
CLIO	02-10	1.6	4	MPFI	2 TERMINALES	BRK-208	75
KANGOO	04-12	1.6	4	MPFI	2 TERMINALES	BRK-208	75
KANGOO EXPRESS	04-11	1.6	4	MPFI	3 TERMINALES	BRK-211	75
LOGAN	15-18	1.6	4	MPFI	2 TERMINALES	BRK-208	75
MEGANE	2008	1.6	4	MPFI	3 TERMINALES	BRK-211	75
	06-08	2.0					

SEAT

MODELO	AÑO	LTS.	CIL.	MODO DE INYECCIÓN	CARACTERÍSTICAS	NO. DE PARTE	
CORDOBA	03-07	2.0	4	MPFI	2 TERMINALES	BRK-213	76
	04-09	1.6					
IBIZA	03-15	2.0	4	MPFI	2 TERMINALES	BRK-213	76
	04-09	1.6					
	16-19						
IBIZA TURBO	2005	1.8	4	MPFI	2 TERMINALES	BRK-214	76
	2008						
	13-17	1.2					

BULBO DE REVERSA**SUZUKI**

MODELO	AÑO	LTS.	CIL.	MODO DE INYECCIÓN	CARACTERÍSTICAS	NO. DE PARTE	
AERIO	06-07	2.3	4	MPFI	2 TERMINALES	BRK-205	75
GRAND VITARA	06-08	2.7	6	MPFI	2 TERMINALES	BRK-205	75
	09-10	3.2					
	09-13	2.4	4				
KIZASHI	11-13	2.4	4	MPFI	2 TERMINALES	BRK-205	75
SX4	08-13	2.0	4	MPFI	2 TERMINALES	BRK-205	75

TOYOTA

MODELO	AÑO	LTS.	CIL.	MODO DE INYECCIÓN	CARACTERÍSTICAS	NO. DE PARTE	
COROLLA XRS	09-10	2.4	4	MPFI	2 TERMINALES	BRK-206	75
HIACE	06-18	2.7	4	MPFI	2 TERMINALES	BRK-206	75
MATRIX	09-10	2.4	4	MPFI	2 TERMINALES	BRK-206	75

VOLKSWAGEN

MODELO	AÑO	LTS.	CIL.	MODO DE INYECCIÓN	CARACTERÍSTICAS	NO. DE PARTE	
BORA	06-09	2.0	4	MPFI	2 TERMINALES	BRK-214	76
BORA TURBO	06-10	2.5	5	MPFI	2 TERMINALES	BRK-213	76
CC	2010	3.6	6	MPFI	2 TERMINALES	BRK-214	76
CC TURBO	2010	2.0	4	MPFI	2 TERMINALES	BRK-214	76
CROSSFOX	11-17	1.6	4	MPFI	2 TERMINALES	BRK-213	76
	07-09						
DERBY	06-09	1.8	4	MPFI	2 TERMINALES	BRK-213	76
EUROVAN	01-03	2.5	5	MPFI		BRK-200	75
EUROVAN VR6	00-02	2.8	6	MPFI		BRK-200	75
GOLF A2	90-92	1.8	4	MPFI		BRK-200	75
		2.0					
GOLF A3	93-98	1.8	4	MPFI	2 TERMINALES	BRK-200	75
		2.0				BRK-213	76
	1999	1.8				BRK-214	76
		BRK-213				76	
		2.0				BRK-214	76
GOLF A3 VR6	95-98	2.8	6	MPFI	2 TERMINALES	BRK-204	75
	1999					BRK-213	76
						BRK-214	76

BULBO DE REVERSA

VOLKSWAGEN

MODELO	AÑO	LTS.	CIL.	MODO DE INYECCIÓN	CARACTERÍSTICAS	NO. DE PARTE	
GOLF A4	00-05	2.0	4	MPFI		BRK-203	75
						BRK-204	
GOLF A4 GTI	00-05	1.8	4	MPFI		BRK-203	75
						BRK-204	
GOLF A4 R32	2004	3.2	6	MPFI		BRK-204	75
	03-04					BRK-203	
GOLF A4 TURBO	00-04	1.8	4	MPFI	2 TERMINALES	BRK-213	76
JETTA A2	89-92	1.8	4	MPFI		BRK-200	75
	90-92	2.0					
JETTA A3	93-98	1.8	4	MPFI		BRK-200	75
		2.0					
JETTA A3 VR6	95-98	2.8	6	MPFI		BRK-204	75
PASSAT	91-93	2.0	4	MPFI		BRK-200	75
	95-97	2.8	6			BRK-204	

BULBO DE REVERSA



BRK-200



BRK-201



BRK-202



BRK-203



BRK-204



BRK-205



BRK-206



BRK-208



BRK-209



BRK-210



BRK-211



BRK-212

BULBO DE REVERSA



BRK-213



BRK-214



BRK-215

BULBO DEPÓSITO ANTICONGELANTE

VOLKSWAGEN

MODELO	AÑO	LTS.	CIL.	MODO DE INYECCIÓN	CARACTERÍSTICAS	NO. DE PARTE	
GOLF A2	87-92	1.8	4	MPFI	12 VOLTS	SNK-100	77
	90-92	2.0					
JETTA A2	87-92	1.8	4	MPFI	12 VOLTS	SNK-100	77
	90-92	2.0					



SNK-100



A hand wearing a white glove holds a silver wrench, while another hand gives a thumbs up gesture. The background is a warm, golden-yellow color.

SopORTE Técnico

COMUNÍCATE CON LOS EXPERTOS

**¡Llámanos!
800 801-5042**

**o envía un correo a:
serviciotecnico@dinamex.com.mx**

KEMPARTS®

PROFESSIONAL
AUTOMOTIVE PARTS



DISTRIBUIDORA TRIEM S.A. DE C.V.

Av. Vasco de Quiroga No. 3900 Corporativo Diamante Santa Fe
Torre "C" Int. 203 C1, Col. Lomas de Santa Fe, Alcaldía Cuajimalpa,
C.P. 05300 Ciudad de México
Tel: 55 5000 6777

**TODOS LOS DERECHOS RESERVADOS, PROHIBIDA SU
REPRODUCCIÓN TOTAL O PARCIAL SIN PREVIA AUTORIZACIÓN.**

